

# OWNER'S MANUAL

## MARINE KETTLE 3<sup>®</sup> GAS GRILL

A10-207-3 • A10-217-3 • A10-207-3-CSA • A10-217-3-CSA  
A10-207-3-CE-2 • A10-217-3-CE-2

**MARINE<sup>®</sup>  
KETTLE** 3



For questions regarding performance, assembly, operation, parts, or returns, contact the experts at MAGMA by calling **(562) 627-0500**  
7:00 a.m. — 5:00 p.m. Pacific Time Monday thru Friday  
or e-mail us at [mail@MagmaProducts.com](mailto:mail@MagmaProducts.com).

Made in the  
**USA** 

Conforms to ANSI Std Z21.72  
Certified to CSA Std 11.2



**Intertek**

**MAGMA<sup>®</sup>**  
U S A

**IMPORTANT, Read These Instructions Carefully Before Use. Familiarize Yourself With the Appliance Before Connecting It to Its Gas Container. Keep These Instructions for Future Reference.**

**THIS PAGE INTENTIONALLY LEFT BLANK**

**MAGMA<sup>®</sup>**  
**U S A**

**⚠ IMPORTANT SAFETY WARNINGS FOR US & CSA GRILL MODELS ⚠**

**READ ALL INSTRUCTIONS BEFORE OPERATING.**

- USE OUTDOORS ONLY.
- DO NOT USE THIS APPLIANCE INSIDE THE BOAT OR ANY ENCLOSED SPACE.
- GRILLS RADIATE HEAT. CLEARANCE FROM COMBUSTIBLES, 24" SIDES AND BACK. NEVER USE UNDER AWNINGS, PATIO COVERS, ETC.
- USE PROPANE GAS ONLY. FUEL STORAGE SHOULD BE IN COMPLIANCE WITH THE AMERICAN BOAT AND YACHT COUNCIL (ABYC) STANDARDS A-1 (9), MARINE LIQUIFIED PETROLEUM GAS (LPG) SYSTEMS.
- FOR NATURAL GAS APPLICATION CONTACT MAGMA.
- ALWAYS LIGHT GRILL WITH LID OPEN.
- NEVER LEAVE HOT GRILL UNATTENDED.
- DO NOT OVERHEAT GRILL, (**SEE "OPERATING INSTRUCTIONS", PAGE 9**).
- ALWAYS TURN GRILL OFF AFTER USE.
- USE GLOVE OR HOT PAD WHEN HANDLING HOT GRILL.
- NEVER LEAVE GAS CYLINDERS AND REGULATOR CONNECTED WHEN STOWED.
- STORE GAS CYLINDERS IN WELL-VENTILATED AREA.
- DO NOT STORE GAS CYLINDERS INDOORS, IN DIRECT SUNLIGHT, BELOW DECKS ON BOATS, OR IN LOCKERS NOT APPROVED FOR BUTANE OR PROPANE STORAGE.
- **CAUTION:** CHECK FOR GAS LEAKS EACH TIME CYLINDER IS CHANGED.
- NEVER CHECK FOR GAS LEAKS WITH A FLAME!
- DO NOT BLOCK, RESTRICT, OR OTHERWISE OBSTRUCT COMBUSTION OR VENTILATION AIR OPENINGS.
- DO NOT MODIFY THIS APPLIANCE.
- KEEP AREA CLEAR AND FREE FROM COMBUSTIBLE MATERIALS, GASOLINE, AND OTHER FLAMMABLE VAPOURS AND LIQUIDS.
- CHECK THAT VALVE SEALING WASHER (**A**) IS IN PLACE AND IN GOOD CONDITION BEFORE CONNECTING THE GAS CONTAINER. (**NOT APPLICABLE TO CE-2 GRILL MODELS**)
- INSTALL CANISTERS IN WELL-VENTILATED AREA AND AWAY FROM OPEN FLAME, HEAT SOURCE OR SPARKS. KEEP AWAY FROM OTHER PEOPLE OR FLAMMABLE MATERIALS.

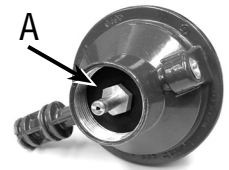

**FOR YOUR SAFETY**

If you smell gas:

1. Do not attempt to light appliance.
2. Extinguish any open flame.
3. Disconnect from fuel Supply.

**POUR VOTRE SÉCURITÉ**

Que faire si vous sentez une odeur de gaz:

1. Ne pas tenter d'allumer d'appareils.
2. Éteindre toute flamme.
3. Couper l'alimentation en gaz à la source.

**FOR YOUR SAFETY**

Do not store or use gasoline or other liquids with flammable vapours in the vicinity of this or any other appliance.

**POUR VOTRE SÉCURITÉ**

Ne pas entreposer ni utiliser d'essence ni d'autres vapeurs ou liquides inflammables à appareil.

**⚠ DANGER**

**CARBON MONOXIDE HAZARD**

This appliance can produce carbon monoxide which has no odor.

Using it in an enclosed space can kill you.

Never use this appliance in an enclosed space such as a camper, tent, car or home.



**⚠ DANGER**

**MONOXYDE DE CARBONE**

Cet appareil peut produire du monoxyde de carbone, un gaz inodore.

L'utilisation de cet appareil dans des espaces clos peut entraîner la mort.

Ne jamais utiliser cet appareil dans un espace clos comme un véhicule de camping, une tente, une automobile ou une maison.



## ⚠ IMPORTANT SAFETY WARNINGS FOR CE-2 GRILL MODELS ⚠

### READ ALL INSTRUCTIONS BEFORE OPERATING.

- USE OUTDOORS ONLY.
- DO NOT USE THIS APPLIANCE INSIDE THE BOAT OR ANY ENCLOSED SPACE.
- GRILL RADIATES HEAT, CLEARANCE FROM COMBUSTIBLES, 24" (61 CM) SIDE AND BACK, NEVER USE UNDER AWNINGS, PATIO COVERS, ETC.
- **CAUTION:** ACCESSIBLE PARTS MAY BECOME VERY HOT. KEEP YOUNG CHILDREN AWAY FROM THE APPLIANCE.
- NEVER LEAVE HOT GRILL UNATTENDED.
- USE GLOVE OR HOT PAD WHEN HANDLING HOT GRILL.
- INSTALL CANISTERS IN WELL-VENTILATED AREA AND AWAY FROM OPEN FLAME, HEAT SOURCE, OR OTHER PEOPLE OR FLAMMABLE MATERIALS.
- **CAUTION:** CHECK FOR GAS LEAKS EACH TIME CYLINDER IS CHANGED.
- DO NOT USE APPLIANCE IF IT HAS DAMAGED OR WORN SEALS; DO NOT USE AN APPLIANCE WHICH IS LEAKING, DAMAGED OR DOES NOT OPERATE PROPERLY.
- NEVER CHECK FOR GAS LEAKS WITH A FLAME!
- IF THERE IS A LEAK ON YOUR APPLIANCE (SMELL OF GAS), TAKE IT OUTSIDE IMMEDIATELY INTO A WELL-VENTILATED, FLAME-FREE, LOCATION WHERE THE LEAK MAY BE DETECTED AND STOPPED. IF YOU WISH TO CHECK FOR LEAKS ON YOUR APPLIANCE, DO IT OUTSIDE. DO NOT TRY TO DETECT LEAKS USING A FLAME, USE SOAPY WATER.
- ALWAYS LIGHT GRILL WITH LID OPEN.
- DO NOT OVERHEAT GRILL, (**SEE "OPERATING INSTRUCTIONS", PAGE 9**).
- DO NOT BLOCK, RESTRICT, OR OTHERWISE OBSTRUCT COMBUSTION OR VENTILATION AIR OPENINGS.
- APPLIANCE MUST BE OPERATED IN THE HORIZONTAL POSITION ONLY.
- DO NOT MODIFY THIS APPLIANCE.
- CHECK THAT BURNERS ARE EXTINGUISHED BEFORE DISCONNECTING THE GAS CONTAINER.
- ALWAYS TURN GRILL OFF AFTER USE.
- CHECK THAT THE GAS CARTRIDGE IS EMPTY BEFORE CHANGING IT (SHAKE TO HEAR THE NOISE MADE BY THE LIQUID).
- NEVER LEAVE GAS CYLINDER (CONTAINER) OR VALVE/REGULATOR CONNECTED WHEN STORED.
- STORE GAS CYLINDERS IN WELL-VENTILATED AREA.
- DO NOT STORE GAS CYLINDERS INDOORS, IN DIRECT SUNLIGHT, BELOW DECKS ON BOATS, OR IN LOCKERS NOT APPROVED FOR PROPANE OR BUTANE STORAGE.
- FOR MODELS A10-207-3-CE-2 AND A10-217-3-CE-2; USE PROPANE/BUTANE MIXED GAS (CAMPINGAZ®) IN CYLINDERS CV-270, CV270 PLUS, CV-470 OR CV470 PLUS. GAS CONSUMPTION ON THESE CYLINDERS IS 0.2 kg/h.
- IT MAY BE HAZARDOUS TO ATTEMPT TO FIT OTHER TYPES OF GAS CONTAINERS.

# CONTENTS



**For US & CSA Models**  
Control Valve/  
Regulator-Type 1



**For CE-2 Models**  
Control Valve/  
Regulator-Type 2



Grill Body

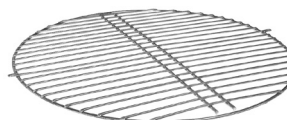

Grill Grate



Dome



Radiant Plate



Match Light Holder  
Included with CSA  
Models Only



Indexing "L" Bracket  
& Clamp Assembly



Turbo Venturi  
Tube Assembly

Tool  
Needed



9/16"  
Wrench  
Not Included

Each Magma® Gas Grill is individually fire tested before it leaves the factory.  
For this reason, the burner on your grill may be slightly discolored.

# SETTING UP YOUR GRILL

Mounts sold separately. See our website [MagmaProducts.com](http://MagmaProducts.com) for mounting options.



1.

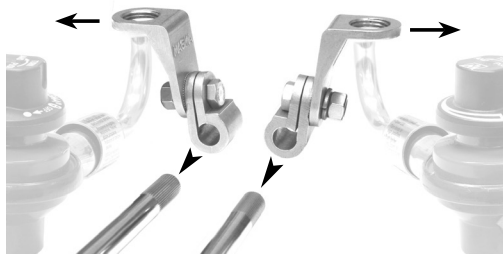

2.

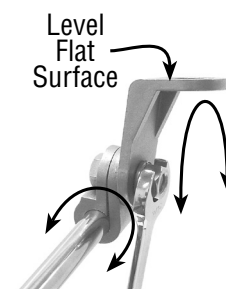

3.

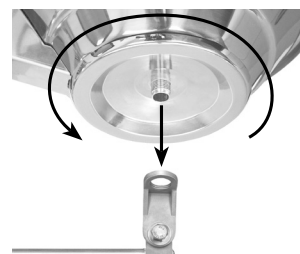

4.

1. Select and install appropriate Magma mount in your desired location. Prior to installing the grill, check that mount does not easily move with a reasonable force applied.
2. Next, decide if gas control valve will be easier to access from the center right side or center left side of grill. This will be based on your placement of the mount (**See picture on front cover**). Now, slide L-Bracket & Clamp on to mount knurled rod so that the threaded flat L-portion of the L-Bracket points in that direction.
3. Adjust threaded flat surface of L-Bracket to level position and tighten firmly with 9/16" or adjustable wrench so that L-Bracket & Clamp cannot be moved. **NOTE:** Level positioning is critical for even temperatures across the cooking surface.
4. Carefully hold the grill body, with the lid closed, and thread on to L-Bracket **VERY TIGHT** so that grill does not unthread easily. Check that grill is tight and level prior to proceeding.

## SETTING UP YOUR GRILL



5.



5a

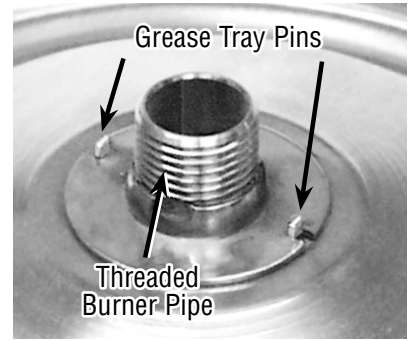

5b



5c

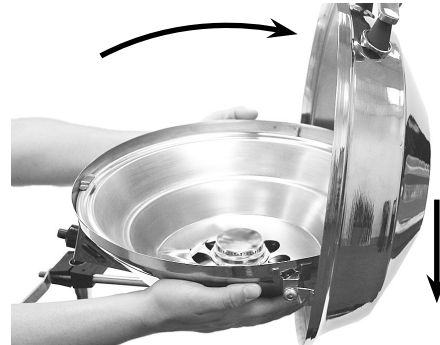

5d

5. With grill body tightly attached to L-Bracket and taking care not to damage electrode, unthread burner **3 full revolutions only**. **CAUTION: DO NOT UNTHREAD MORE THEN 3 REVOLUTIONS, AS GRILL MAY FALL OVERBOARD.**
- Lift entire grill up to disengage from grease tray positioning pins (5a & 5b) and rotate so lid operates freely in desired position (5c).
  - Carefully lower back down (5d), making sure pins are re-engaged and rethreaded “burner” back 3 revolutions until tight. If burner does not turn 3 revolutions the pins are not engaged properly.



6.



7.

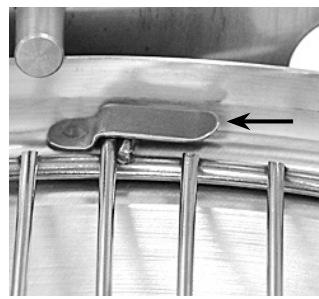

7a

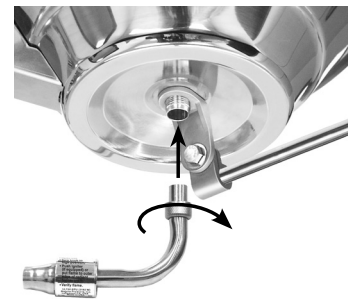

8.

6. Install radiant plate & dome over burner on fire pan ridge.
7. Install grill grate by rotating grate so that both grill grate tabs slide under the holding clips (7a), locking grate and all internal components in correct position.
8. Insert the turbo venturi tube into the threaded pipe on the bottom of the grill body and firmly tighten the threaded nut so nut doesn't turn while rotating the turbo venturi tube. **NOTE:** Turbo Venturi Tube should still rotate freely. Venturi tube should be stowed with valve in a clean dry environment when not in use. (See “Stowing Tips”, Page 9) Before each use, prior to inserting venturi tube, check that the threaded pipe is free of spider webs or other obstructions.

# CONNECTING FUEL SOURCE

## US & CSA — CONTROL VALVE REGULATOR A10-207-3 • A10-217-3

- Uses standard 1-lb. disposable propane canisters (DOT-39 NRC).
- Prior to installing valve, become familiar with the valve function and graphics on valve knob. Never force the knob. Always turn or push gently.
- Turn control valve to “LOCK” and install gas canister being careful not to cross the threads. Check for leaks prior to use, by brushing soapy water solution around threads and orifice hole checking for bubbles.
- Position valve with gas bottle as shown (A). Gently insert valve stem into the turbo venturi tube. Rotate until valve stem key aligns with lock detent allowing valve to fully insert. Rotate gas canister down (B).

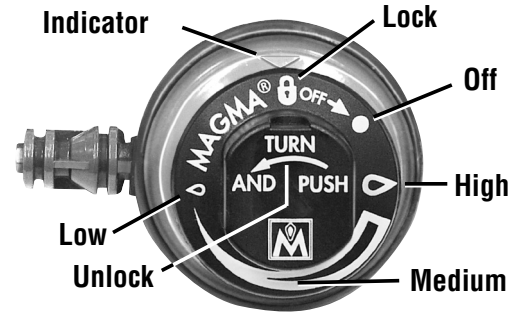

**Valve will feel loose and will rotate easily. Even though the valve feels loose, it is designed that way and will not leak. The valve was designed to be loose fitting in order to allow safe, easy installation and removal of the propane canister and so it easily swings without resistance to fit all applications.**

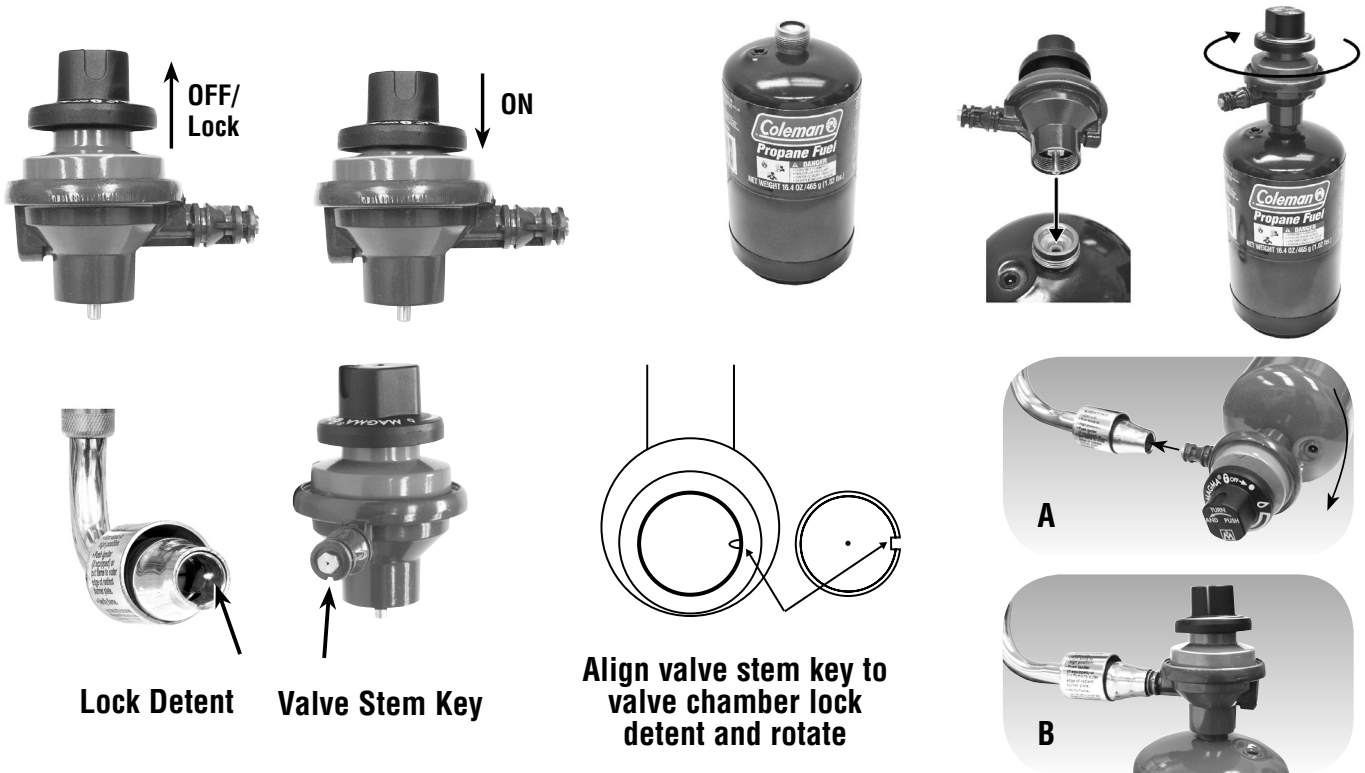

## CE-2 — CONTROL VALVE REGULATOR A10-207-3-CE-2 • A10-217-3-CE-2

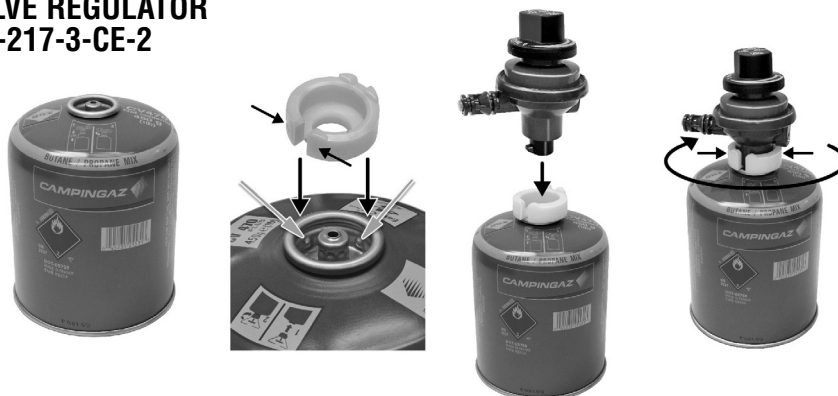





## OPERATING PROCEDURES

**WARNING:** Do not overheat grill. Magma grills do not require pre-heating. Stainless Steel loses anti-corrosive characteristics when subjected to extreme heat. Most grilling is done on low temperature with the lid closed. If medium or high heat is required, grill with lid open.

### LIGHTING INSTRUCTIONS

- Open lid during lighting. • Depress knob & rotate counter-clockwise to the “HIGH” position.
- Push Electronic Pulse Igniter. • Visually confirm ignition. • Turn knob to adjust flame.
- If grill does not light, ensure that a burner electrode spark cap is directly above electrode.
- If the Electronic Pulse Igniter continues to fail to ignite the gas, (**See MATCH LIGHTING INSTRUCTIONS**).

**NOTE:** Electronic ignition comes equipped with battery pre-installed. Replace with “AAA” alkaline battery only.

### MATCH LIGHTING INSTRUCTIONS

(Backup system allows use of grill until Electronic Pulse Igniter system is repaired.)

- Open lid during lighting.
- Place flame up to burner through the match light hole.
- Depress valve and turn counter-clockwise to the “High” position.
- Visually confirm ignition.



### TO REDUCE FLARE-UP

- Trim excess fats from meat. • Reduce heat.
- Use non-oil based marinades. • Use water spray directly on flare-ups.

**To help create your own Magma gourmet experience every time you grill, please check these important critical points prior to lighting your grill.**

- Mount is secure and grill does not move. • Electrode is clean and electronic ignition creates a spark.
- Grease tray and fire pan are clean from excess drippings to reduce flare up and ensure even air flow.
- Lid is correctly positioned to operate freely and is in best position for blocking the wind.
- Venturi tube, burner, threaded burner pipe and valve orifice are free of obstructions, such as spider webs.
- Radiant plate is positioned correctly. • Grill grate is in locked position under holding clips.
- Turbo Venturi Tube holding nut is tight & doesn't turn when rotating valve position.
- Valve is installed and locked into Turbo Venturi Tube properly. • Sufficient fuel is available.

### COOKING TIPS

- The most common mistake when grilling is using too high of a heat setting. Grills become hotter as you cook, so **use moderate heat settings when cooking with lid closed**.
- Always keep a water spray bottle handy for flare-ups and quick cooling if grill overheats.
- Coat the grill grate with vegetable or olive oil to prevent food from sticking.

### STOWING TIPS

- Always disconnect the fuel canister from the valve prior to stowing.
- Stow the valve and Turbo Venturi Tube in a clean, dry area to protect from corrosion to valve and spider web obstructions in venturi tube.
- Always stow by unthreading the entire grill from the L-Bracket. Do not remove the L-Bracket & Clamp unless repositioning is necessary.
- Always store propane in a sealed propane storage locker that allows leakage to vent overboard or use **Magma A10-210 Propane Storage Tote**. Never stow below decks.

## USING THE MARINE KETTLE AS A STOVE

Magma's patented, unique design of the Marine Kettle allows it to be used as a conventional stove. This permits you to fry, saute, boil, wok, etc. • Remove the grill grate. • Remove the radiant dome • Adjust flame to proper cooking temperature.



- For smaller pots/pans, place the cookware directly on the three tongs of the radiant plate.
- For larger pots/pans, including woks, invert the radiant plate and place the cookware directly on the radiant plate.

## MAINTENANCE

### COMPLETE DISASSEMBLY FOR CLEANING (OR ACCESS TO ELECTRONIC PULSE IGNITER)

1. Remove entire grill body from L-Bracket of Mount.
2. Unthread and remove burner, fire pan and grease pan from outer bowl.
3. To inspect Electronic Pulse Igniter, remove single screw from inside of outer bowl to release igniter box and carefully inspect for corrosion or loose wire connection.
4. To reassemble, reverse above steps and steps 5 through 8 (See **“Setting Up Your Grill”**, Page 6).

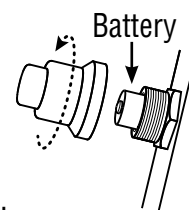

Stainless Steel, contrary to popular belief, can rust. Most commonly, deposits on the surface of the product will trap moisture. It is this moisture that robs the stainless steel of oxygen. Oxygen is the element that reacts with the stainless steel to form a protective layer of chrome oxide. Robbed of oxygen this reaction does not take place and “crevice corrosion”, or “surface rusting”, occurs. To minimize this effect, thoroughly clean your grill with soap and water, rinse with fresh water and dry. Avoid using products designed to clean stainless steel as most leave a residue that may discolor when the grill is heated.

Additionally, stainless steel that is exposed to high heat will change color and texture over time. The “amber” color of grill exterior and internal components is not a failure of the stainless steel and will not affect the product's operation. When this happens, we recommend using **“Magma Magic” Grill Restorer** to remove the “amber” color and return grill to its original luster. However, prolonged exposure to extreme high heat will cause chromium and nickel to “burn out” of stainless steel. At this point stainless steel will become more susceptible to corrosion and will start to deteriorate. We recommended replacement of internal components as they become seriously deteriorated.

We recommend thorough cleaning of all internal parts after each outing. It is important to disassemble the interior components and remove any food residue. A soft “Scotch-Brite” pad or similar product may be used in this process. For heavier burned-on stains we recommend “Easy-Off Oven & Grill Cleaner” followed by thorough washing with soap and water, rinse with fresh water and dry. **AVOID CONTACT OF OVEN CLEANER WITH CONTROL VALVE, IGNITER ELECTRODE & WIRE, AND BOAT SURFACES. CAUTION: DO NOT USE ANY TYPE OF ABRASIVE PAD ON THE EXTERIOR MIRROR FINISH AS IT WILL SCRATCH THE SURFACE. USE ONLY A SOFT COTTON CLOTH.** We recommend covering the grill between uses. Grill covers are available at Magma retailers or directly from Magma. See our website, [MagmaProducts.com](http://MagmaProducts.com).

### GRILL GRATES

Clean with brass wire brush while grill is warm. Use Oven & Grill cleaner for burnt-on residue. Wash with soapy water and dry prior to storage.

### CERAMIC ELECTRODE

Located just beside the burner, it should be kept clean of grease and debris. Burner ground strap must be directly over the electrode for proper operation, be careful not to damage the ceramic insulation or the wire.

### CONTROL VALVE

All valves are set and tested at our factory. Do not attempt to adjust or disassemble the valve. Call Magma if you suspect it is not adjusted properly. Clean valve with a cloth and remove any debris obstructing the orifice.

### REPAIR/REPLACEMENT PARTS

All replacement parts are readily available at your Magma Retailers or directly from Magma. For a complete list of replacement parts, **see page 11**, or visit our website [MagmaProducts.com](http://MagmaProducts.com).

# REPLACEMENT PARTS

**A10-207-3, A10-207-3-CSA — “Original” Size**  
**A10-217-3, A10-217-3-CSA — “Party” Size**

**A10-207-3-CE-2 — “Original” Size**  
**A10-217-3-CE-2 — “Party” Size**

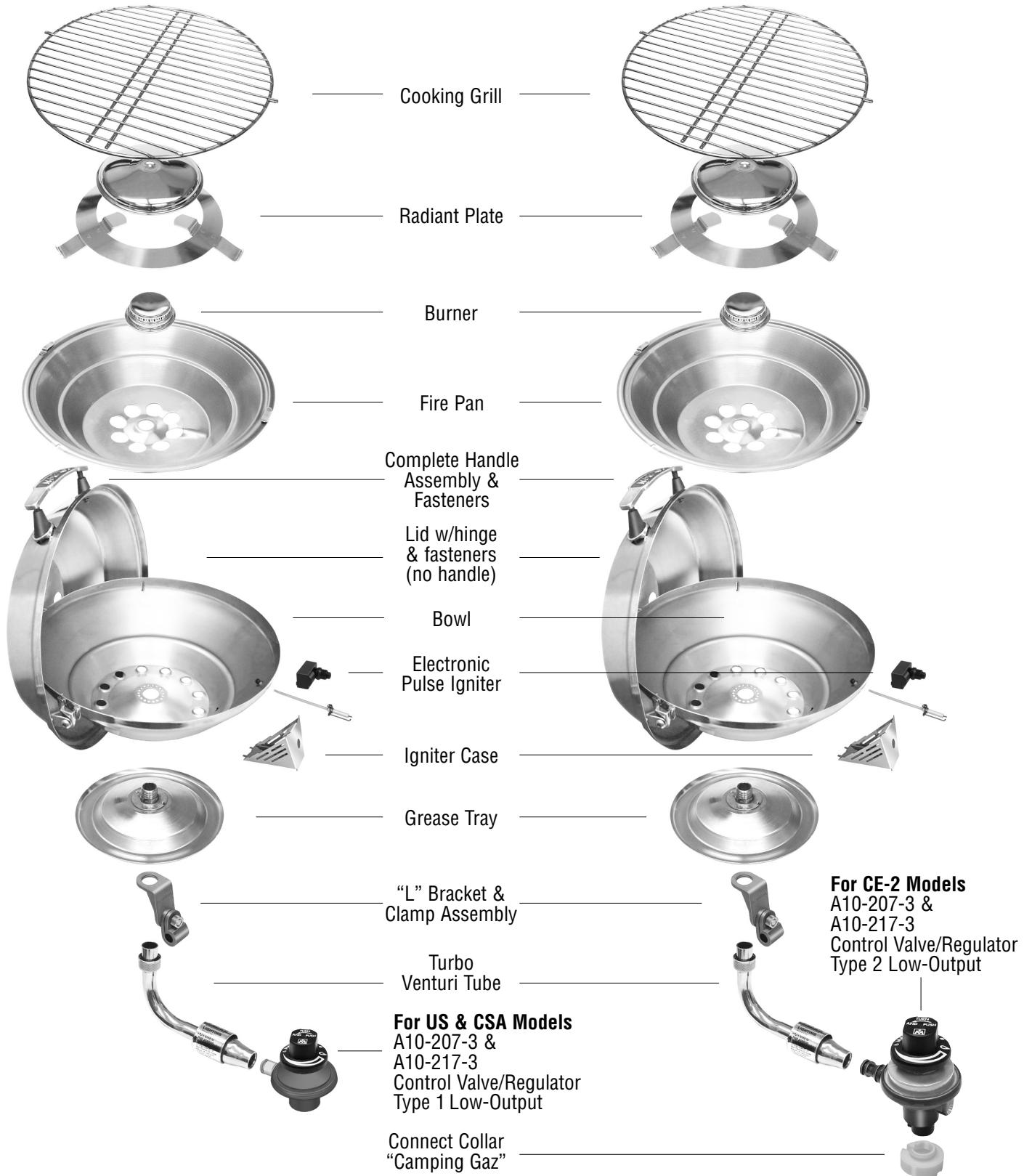

**See MagmaProducts.com For Correct Part Numbers For The Replacement Parts Above**

# TROUBLESHOOTING GUIDE

PROBLEM	POSSIBLE CAUSE	POSSIBLE SOLUTION
<b>BURNER WILL NOT LIGHT WITH IGNITER</b>	Electrode covered with grease or residue	<ul style="list-style-type: none"> <li>• Clean electrode</li> </ul>
	Electrode wire loose, disconnected, or corroded	<ul style="list-style-type: none"> <li>• Clean, adjust &amp; reconnect wire between igniter &amp; electrode, (<b>See “Complete Disassembly”, Page 10</b>)</li> </ul>
	Wire is shorted causing spark from wire before electrode	<ul style="list-style-type: none"> <li>• Replace Igniter, Electrode &amp; Wire (<b>See Page 11</b>)</li> </ul>
	No spark being generated	<ul style="list-style-type: none"> <li>• Adjust electrode until proper spark appears</li> <li>• Unscrew igniter push button, remove/inspect “AAA” battery, replace “AAA” alkaline battery if necessary, reinstall and re-assemble push button</li> <li>• Replace Igniter, Electrode &amp; Wire (<b>See website for part number</b>)</li> </ul>
<b>BURNER WILL NOT LIGHT EVEN WITH MATCH</b>	No gas flow	<ul style="list-style-type: none"> <li>• Check fuel level, replace canister or refill cylinder</li> </ul>
	Obstructed gas flow	<ul style="list-style-type: none"> <li>• Clean burner, turbo venturi tube, and valve orifice. Remove debris/spider webs</li> </ul>
<b>FLARE-UP</b>	Excessive cooking temperature	<ul style="list-style-type: none"> <li>• Operate only on low when lid is closed</li> <li>• Reduce flame level</li> <li>• Leave lid open</li> <li>• Use water spray to cool</li> </ul>
	Grease and/or residue build-up	<ul style="list-style-type: none"> <li>• Clean components</li> </ul>
	Excessive fat in meats	<ul style="list-style-type: none"> <li>• Trim fat from cuts of meat before grilling</li> </ul>
	Excessive oils in marinades	<ul style="list-style-type: none"> <li>• Use non-oil based marinades</li> </ul>
<b>YELLOW SOOTY FLAME</b>	Obstructed gas flow	<ul style="list-style-type: none"> <li>• Clean burner, turbo venturi tube, and valve orifice. Remove debris/spider webs</li> </ul>
<b>BLOW-OUT</b>	Flame too low	<ul style="list-style-type: none"> <li>• Increase flame</li> </ul>
	Wind directly on burner	<ul style="list-style-type: none"> <li>• Block wind with lid. (<b>See Page 6</b>)</li> </ul>
	Obstructed gas flow	<ul style="list-style-type: none"> <li>• Clean burner, turbo venturi tube, and valve orifice. Remove debris/spider webs</li> </ul>
<b>HOT SPOTS</b>	Grill not level	<ul style="list-style-type: none"> <li>• Level Grill. (<b>See Page 5</b>)</li> </ul>
	Grease or residue build-up	<ul style="list-style-type: none"> <li>• Clean components</li> </ul>
	Excessive fat in meats	<ul style="list-style-type: none"> <li>• Trim fat from cuts of meat before grilling</li> </ul>
	Excessive oil in marinades	<ul style="list-style-type: none"> <li>• Use non-oil based marinades</li> </ul>

# ACCESSORIES



**Magma® Marine Kettle® Grill Cover/Tote Bag**  
Original & Party Size



**Fully "Nesting," 7 & 10 piece, 18-10 Stainless Steel Cookware Sets with Stainless Steel or Ceramica Non-Stick Interiors**  
Stainless Steel, Cobalt Blue, Jet Black, or Magma Red Enamel exteriors and Induction compatible models available.



Stores in less than 1/2 cubic foot



**Luggage Quality Padded Grill & Accessory Carry/Storage Case**  
Fits grills up to 17" dia. (43 cm)



**LED Grill Light**  
High-intensity LED light for grilling after dark



**"Telescoping" Grill Tools & Storage/Carrying Case**  
Grill Tool Set, 5 Piece  
Individual tools also available

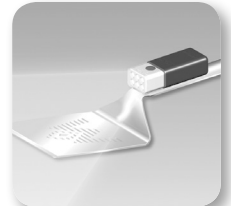

**LED Grill Tool Light**  
High-intensity LED light easily attaches to any Magma Telescoping Grill Tool



**Fish & Veggie Grill Tray**  
18-9 Stainless Steel or 18-9 Stainless Steel with Non-Stick



**Reversible "Non-Stick" Griddle**  
Heavy duty marine grade cast aluminum with Non-Stick Coating



**Gourmet Grilling Apron**  
100% cotton, adjustable with embroidered Magma logo, 2 pockets, and towel loop  
Jet Black or Magma Red



**Grill Mitt**  
100% quilted heat resistant cotton construction with embroidered Magma logo & silicone palm and thumb • Jet Black



**"Flat" Kabob Skewers**  
25 skewers per pack 100% Hygienic Bamboo Food won't roll when turned

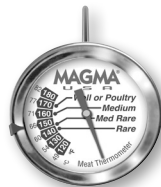

**Gourmet Meat Thermometer**  
304 Marine Grade Stainless Steel  
2" Face



**Gourmet Steak-O-Meters**  
4 Pack - 304 Marine Grade Stainless Steel  
1" Face

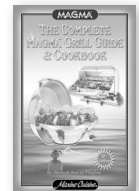

**"Marine Cuisine"® Grill Guide & Cookbook**  
130 pages of recipes & tips for portable grilling



**LPG (Propane) Low Pressure Gas Grill Connection Kit**  
for on-board LPG (Propane) systems • North America Only



**Low Pressure Control Valves for on-board LPG (Propane) or CNG (Natural Gas) gas systems**  
See website for correct part number



**Propane/Butane Canister Storage Locker/Tote Bag**  
Holds up to (3) 1-lb. (450 g) propane canisters  
Pacific Blue & Jet Black



**Magma Magic Grill Restorer**  
Removes amber color from all Magma Grills • USA only

See Our Website [MagmaProducts.com](http://MagmaProducts.com) for a Complete List of Accessories

## LIMITED WARRANTY

Magma Products, Inc. guarantees this product to be free from defects in materials or workmanship to the original consumer. This guarantee is for the periods herein specified when used under normal and reasonable conditions, one (1) year from the date of original purchase. This warranty does not include the cost of property damage or any inconvenience due to the failure of the product. Nor does it cover damage due to misuse, abuse, accident, or damage resulting from transportation of the product. Nor does it include damage resulting from the commercial use of this product. Nor does it include, on stainless steel products, "Surface Rust"; Excessive Corrosion due to exposure to salt water; or Discoloration or Corrosion caused by exposure to excessive heat or failure to properly clean and care for the stainless steel surfaces. If the product fails to operate due to a defect in materials or workmanship during the warranty period, the defective part will be repaired or replaced at Magma's option. If you wish to obtain performance under this limited warranty, you should contact Magma's Customer Service Department via telephone at (562) 627-0500, or via e-mail at [mail@MagmaProducts.com](mailto:mail@MagmaProducts.com), or via U.S. Postal Service mail at "Magma Products, Inc., Attention Customer Service, 3940 Pixie Ave. Lakewood, CA, 90712". The defective part, along with proof of purchase, must be returned postage prepaid to Magma Products, Inc. We suggest that you keep your purchase receipt as we may require reasonable proof of purchase.

In the state of California only, if refinishing or replacement of the product is not commercially practicable, the retailer selling the product, or Magma Products, Inc., will refund the purchase price paid for the product, less the amount directly attributable to use by the original consumer prior to the discovery of the nonconformity. In addition, in the state of California only, you may take the product to the retail establishment from which it was purchased or to any retail establishment selling this product in order to obtain performance under this warranty. All implied warranties, including the implied warranties of merchantability and fitness for a particular purpose, are limited in duration to the express warranty periods specified herein for the parts described herein. Some states do not allow limitations on how long an implied warranty lasts, so the above limitation may not apply to you. Neither Magma dealers, nor the retail establishment selling this product has any authority to make any warranties or to promise remedies in addition to or inconsistent with those stated above. Magma's maximum liability shall not exceed the purchase price of the product paid by the original consumer. Some states do not allow the exclusion or limitation of incidental or consequential damages, so the above limitation or exclusions may not apply to you. The warranty gives you specific legal rights and you may also have other rights which vary from state to state.

MAGMA and the Magma logo are registered trademarks of Magma Products, Inc. • Patent pending.

**CALIFORNIA PROPOSITION 65 – WARNING** – The burning of gas cooking fuel generates some by-products, which are on the list of substances, which are known by the State of California to cause cancer or reproductive harm. California law requires businesses to warn customers of potential exposure to such substances. To minimize exposure to these substances, always operate this unit according to the use and care manual, ensuring you provide good ventilation when cooking with gas.

*U.S. PATENTS • 4,788,962 • 5,330,154 • 5,413,090 • D 292,163  
Other Patents and Design Patents Pending*

# MAGMA<sup>®</sup>

U S A

**MAGMA PRODUCTS, INC.**  
**3940 Pixie Avenue, Lakewood, CA 90712 • USA**  
**(562) 627-0500 • [mail@MagmaProducts.com](mailto:mail@MagmaProducts.com)**  
**[MagmaProducts.com](http://MagmaProducts.com)**

## ADDENDUM FOR GAS GRILL MODELS A10-207-3AU-1, A10-217-3AU-1 SOLD IN AUSTRALIA

**CAUTION:** Accessible parts may be very hot. Keep young children away. ONLY USE IN WELL-VENTILATED AREAS. • CARBON MONOXIDE HAZARD-THIS APPLIANCE CAN PRODUCE CARBON MONOXIDE WHICH HAS NO ODOUR. DO NOT USE IN ENCLOSED AREAS, (FOR EXAMPLE: CAR, TENT, CARAVAN, MOBILE HOME) MAY CAUSE DEATH. This appliance shall only be used in an above ground, open air situation with natural ventilation, without stagnant areas, where gas leakage and products of combustion are rapidly dispersed by wind and natural convection.

Any enclosure in which the appliance is used shall comply with one of the following:

(A) An enclosure with walls on all sides, but with no overhead cover.

**Outdoor Area  
Example 1**

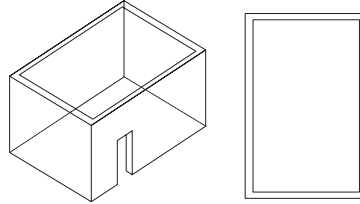

(B) Within a partial enclosure that includes an overhead cover and no more than two walls.

**Outdoor Area  
Example 2**

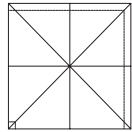
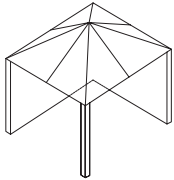

**Outdoor Area  
Example 3**

*Both ends open*

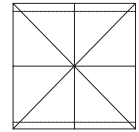
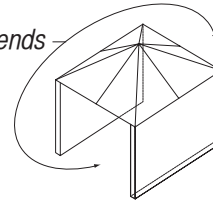

(C) Within a partial enclosure that includes an overhead cover and more than two walls, the following shall apply:

- (1) At least 25% of the total wall area is completely open.
- (2) 30% or more in total of the remaining wall side, back and front wall areas is open and unrestricted.
- (3) In the case of balconies, 20% or more of the total wall area shall remain open and unrestricted.

**Outdoor Area  
Example 4**

*Open side at least 25% of total wall area*

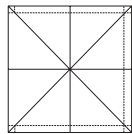
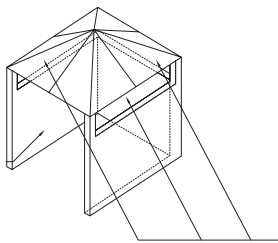

*30% or more in total of the remaining wall area is open and unrestricted*

**Outdoor Area  
Example 5**

*Open side at least 25% of total wall area*

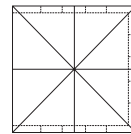
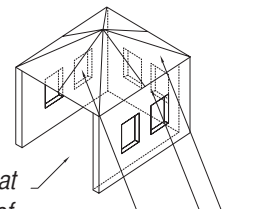

*30% or more in total of the remaining wall area is open and unrestricted*

- Use appliance only in horizontal position. • This appliance must only be serviced by an authorized person.
- Do not use this appliance if it has damaged or worn seals. • Do not move this appliance during operation.

**FUEL CONTAINERS:** Change gas containers in well-ventilated areas, preferably outside, away from people & sources of ignition; such as naked flames, pilot flames, electric heaters/equipment. Do not use appliance if it is leaking, damaged, or not working properly. Check that burners are extinguished before removing gas container. To check if gas cylinder is empty, remove regulator/valve and shake listening for liquid in cylinder; if no liquid sounds are heard, cylinder is empty.

**GAS LEAKS: NEVER CHECK FOR GAS LEAKS WITH A FLAME!** Check for gas leaks by applying a soapy solution to connections. If bubbles appear, turn off appliance and repair leaks as necessary.

**HOW TO ISOLATE GAS SUPPLY IN THE EVENT OF A LEAK (Smell of Gas):**

**CARTRIDGES:** If there is a leak on your appliance (smell of gas) and you cannot stop the gas flow, remove the appliance to a well ventilated location away from any ignition source.

**CYLINDERS:** If there is a leak on your appliance (smell of gas), immediately attempt to turn off cylinder valve. Turn off appliance control valve. Remove appliance to a well-ventilated location away from any ignition source.

**STORAGE: NEVER LEAVE GAS CYLINDERS CONNECTED WHEN NOT IN USE!**

**CYLINDERS:** When you have finished using this appliance, turn gas cylinder off; wait for the flame to go out and turn the appliance control valve off. Remove appliance control valve from appliance and store control valve in a dry, non-corrosive environment. • Store fuel containers outdoors, in a well ventilated area, out of reach of children, never below decks on boats. (Any indoor storage shall comply with Section 2 Minor storage and usage of AS/NZS 1596).

**HOSES:** Only use the hose assembly as supplied with this appliance for connection to the cylinder — DO NOT USE ADAPTORS. Use RECA 8 mm hose and regulator (AGA Cert No:7214, Hose 8 mm LP class A, Regulator RECA 718 or 698 2kg/hr). Connections must be spanner tight per AGA requirements. Make sure gas hose is in good condition and avoid twisting or kinking.

**PACKING MATERIALS: BEFORE INSTALLATION OR USE!**

- Open package containing grill and components, remove all contents.

**PACKAGE CONTENTS:**

- Grill body
- Grill cooking grate
- Components package
- Remove grill from plastic bag.
- Open grill lid and remove, small, components package.

**COMPONENT PACKAGE CONTENTS:**

- Radiant burner plate and dome assembly
- Turbo venturi tube and control valve/regulator assembly
- L-bracket assembly, for attaching grill to mounting option
- Product owner's manual
- Remove all components from box and paper bags.
- All necessary assembly instructions are detailed in the provided owner's manual.

The burner should be snug, but not over tightened. Ensure that one end of the burner ground strap is positioned directly over the electrode. With the ground strap above the Electrode Wire, the gap must be 1.28 mm (0.050 in). Use the included feeler gauge to confirm and/or adjust for the correct gap. Adjustment is made by slightly bending the end of the ground strap, up or down depending on the need. Check for spark and immediate ignition before normal use.

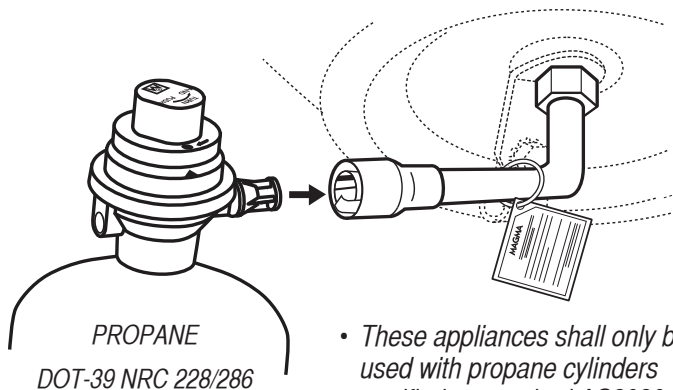
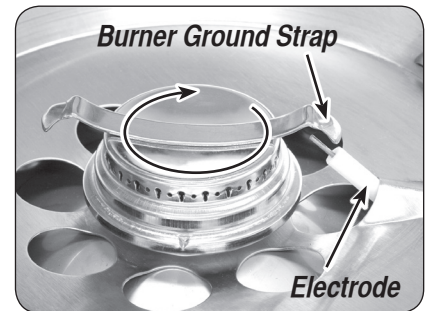
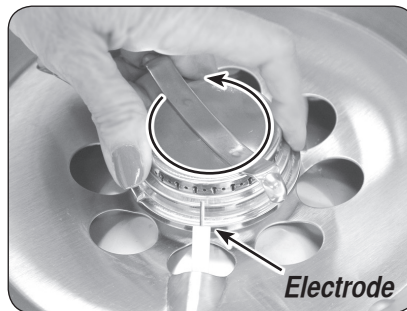

- These appliances shall only be used with propane cylinders certified to standard AS2030.
- It may be hazardous to attempt to fit other types of gas containers.

**Coleman Type Disposable Cylinders**  
Models A10-207-3AU-1 & A10-217-3AU-1

- Orifice size for models A10-207-3AU-1 and A10-217-3AU-1 is 0.73 mm.
- The nominal gas consumption for models A10-207-3AU-1 and A10-217-3AU-1 is 11.3 MJ/H.