

WITH MORE THAN 60 YEARS OF EXPERIENCE IN COMPRESSOR TECHNOLOGY AND HIGHLY DEDICATED EMPLOYEES, OUR FOCUS IS ON DEVELOPING AND

APPLYING ADVANCED COMPRESSOR TECHNOLOGIES TO ACHIEVE STANDARD SETTING PERFORMANCE FOR LEADING PRODUCTS AND BUSINESSES AROUND THE WORLD.

SECOP

CONTROLLERS FOR BD COMPRESSORS

OPERATING INSTRUCTIONS (BD P-Housing)

101N0212 Standard, 12/24 V DC
101N0340 AEO, 12/24 V DC
101N0390 High Speed, 12/24 V DC
101N0420 Solar, 10-45 V DC
101N0510 AC/DC, 12/24 V DC, 100-240V AC
101N0650 Automotive, 12/24 V DC



TABLE OF CONTENTS

1. Introduction	3	8. Condenser fan	16
1.1 Applications	3	9. Thermostat	17
1.3 Functions	3	9.1 Thermostat type	17
2. Technical data & specifications	4	9.1.1 Electronic thermostat (NTC sensor)	17
2.1 Technical data	4	9.1.2 Mechanical thermostat	17
2.2 Specifications	4	9.2 Thermostat delays	17
3. Wiring	5	10. Communication	18
3.1 Wiring diagram	5	Lost communication	18
3.2 Wiring diagram	5	Node Number	18
3.3 Wiring diagram	5	Protection of settings	18
3.4 Wire dimensions	6	11. Product information	19
4. Menu overview	7	12. Error and Event Log	20
4.1 User interface	7	12.1 Actual Error	20
4.2 Operation	7	12.2 Error Log	20
5. Parameters	8	12.3 Event Log	20
Description of parameters	8	13. Inverter temperature (PCB)	21
6. Battery protection	9-10	14. Ordering	22
6.1 Solar mode	10	15. One wire/LIN gateway	23
7. Compressor speed	11	MODBUS Parameter identification scheme	24-27
7.1 Compressor speed control modes	12	16. Installation of software	28
7.1.1.1 Speed control Mode 1	12	Install and configure software	28-29
7.1.1.2 Speed control Mode 1	12-13	Install product key	30
7.1.2 Speed control Mode 2	14	Connect network	31-32
7.1.3 Speed control Mode 3	14	Ready to operate	33
7.1.4 Speed control Mode 4	14		
7.2 Compressor min. and max. speed protection	15		

1.

INTRODUCTION

1.1 Applications

The BD35F, BD35K, BD50F, BD80CN, BD100CN and BD250GH.2 compressor systems are mainly introduced for mobile refrigerators and freezers. The operating conditions are Low/Medium/High Back Pressure (LBP/MBP/HBP). The system is able to operate in ambient temperatures up to +55 °C (131 °F). All electronic units are HST types (High Starting Torque) except 101N0420 (Solar).

Typical applications for the electronic units are:

- Truck refrigerators and freezers
- Boat refrigerators and freezers
- Bus refrigerators and freezers
- Portable boxes
- Solar cabinets
- Agriculture
- RV

The 101N0212 controller is intended for a variety of DC-powered applications, while the 101N0650 is intended for automotive applications, where requirements to EMI and leakage current are important. 101N0340 is mainly intended for condensing units or systems with bigger load variations. It replaces the controllers 101N0300/320/330.

101N0390 is intended for BD80F, BD100CN, and BD250GH.2.

101N0420 is intended for direct solar driven applications and replaces 101N0400 and 101N0410

101N0510 is the new AC/DC unit and replaces 101N0500

1.2 Functions

The main functions of the controllers are:

- Motor / Compressor speed control
- Thermostat control (ON / OFF or electronic via NTC temperature sensor)
- ECO function to optimize compressor speed for minimum power consumption
- Fan control
- Error LED
- Communication interface
- Monitoring function
- Error & event log
- Battery protection functions
- Main Switch
- Log of specific parameters via Tool4Cool® software
- Optimization of specific parameters via PC software before commencing mass production
- Parameter setting via PC or resistors
- AEO (Adaptive Energy Optimizing) in selected models (101N0340, 101N0390 and 101N0420)

2. TECHNICAL DATA & SPECIFICATIONS

Below is a list of key parameters of the new electronic units (controllers).

2.1 Technical data

Input voltage	9.0-32 V DC 10-45 V DC (Solar unit) 100 -240 V AC (AC/DC unit)
Min./max. operating temperature	-10 to +55 °C
External fuse required	15 A @ 12 V, 7.5 A @ 24 V, slow blow type
Starting current	15 A @ 12 V, 7.5 A @ 24 V
Leakage current 101N0212/340/390/420/510	<= 4 mA @ 12 V, < 6 mA @ 24 V
Leakage current 101N0650	<= 150 µA @ 12 V, < 170 µA @ 24 V
EMC approval 101N0212/340/390/420/510	Compliant to 2004/104/EC (e-marking) EC declaration 2004/108/EC CISPR 25 Class 1 CISPR 14
EMC approval 101N0650	Compliant to 2004/104/EC (e-marking) EC declaration 2004/108/EC CISPR 25 Class 4 in all operating modes CISPR 25 Class 5 except 80-82 Mhz radiated emission with 12 V supply at 3500 rpm
NTC type to be connected	Epcos M800/5K
Fan output	5 W, nominal voltage 12 V <ul style="list-style-type: none"> • Use a fan with over/undervoltage protection • A 12 V fan must also be used in 24 V systems

2.2 Specifications

Test name	Standard	Conditions
Temperature shock	VW 801 01: 2009-03 sec 5.2.2	-40/+105 °C, 10 sec, 75 cyc/min., 300 cyc
Vibration	Freightliner Eng Std 49-00085	5-500 Hz, 4 g, X-Y-Z axis, 3x3 h each
Salt Mist	VW 801 01: 2009-03 sec 5.5.4	Powered, 1 of 8 hours running, 6x8 h spray on/16 h off, 5 % NaCL, 35 °C, 1-2 ml/80 cm ³ /h
Corrosion	ASTM G85 Annex 5	0.05 % NaCL + 0.35 % ammonia sulphate, 35 °C, 6 h of 1 h on/1 h off repeated
Gas exposure		6h, 75 % RH, 0.5 % H ₂ S + 0.5 % SO ₃
Thermal cycling with humidity	EN60068-2-35 test Db	-10/+55 °C, 97 % RH, 3 weeks, compressor running intermitting
Storage	VW 801 01: 2009-03 sec 5.1.1	+90 °C 96 h, -40 °C 24 h
IP test	EN 60529 Edition 2.1 2001-02	Min. IP 20
Free fall	IEC 60068-2-32	1 m, concrete, 2 times 2 sides
Thermography		0/60/60 °C max. speed, solder below 110 °C, components acc. to Secop derating guideline
Thermal performance		Steady state: 15/60/60 °C @ 2000, 10/60/60 °C @ 2500, 5/60/60 °C @ 3000, 0/60/60 °C @ 3500. Pull down, 5 min. without cutout: 15/70/60 °C @ 2000, 15/70/60 °C @ 3500.

3. WIRING

3.1
Wiring diagram
101N0212, 101N340,
101N0390, 101N0650

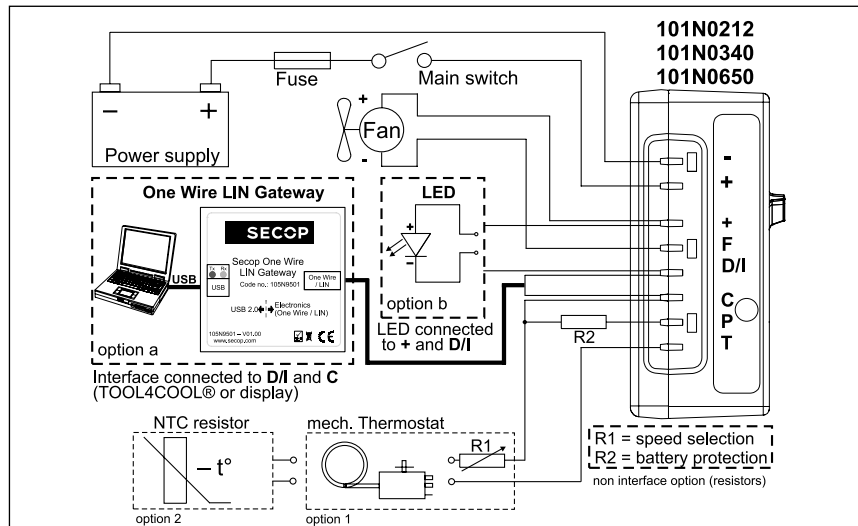

3.2
Wiring diagram
101N0420

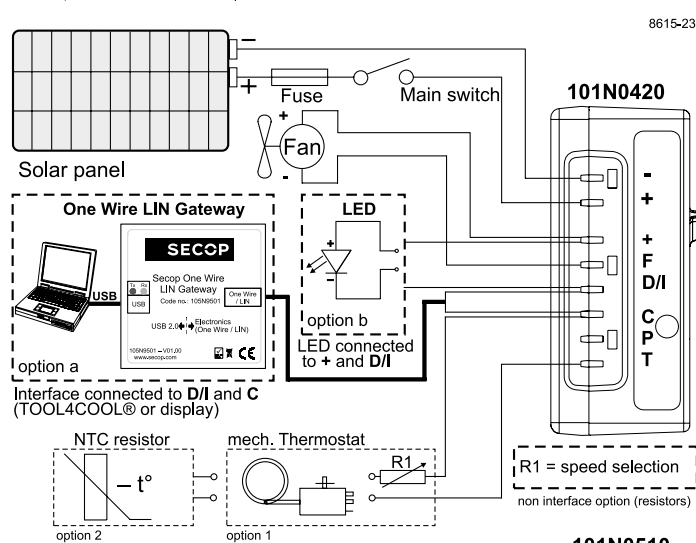

3.3
Wiring diagram
101N0510

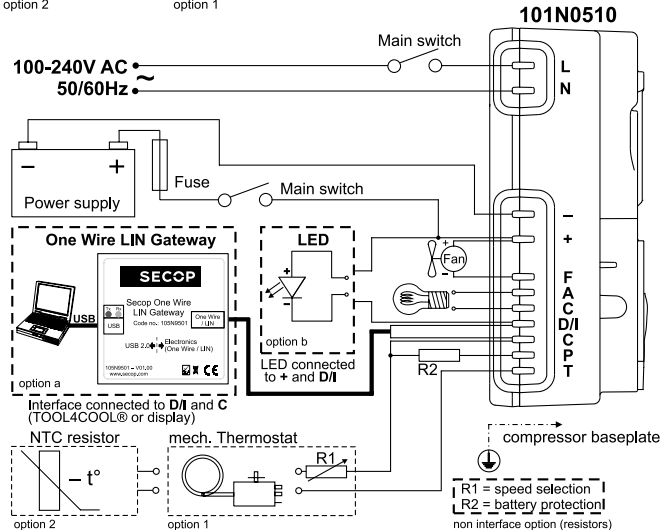

**101N0212, 101N340,
101N0390, 101N0420,
101N0650**

The compressor control units have the following connections:

- , + Main supply voltage. Nominal voltage 12 V DC and 24 V DC, range: 9.0 to 32 V DC.
- + , F Fan connection, max. 5 W, connect always 12 V fan (even in 24 V systems).
- D/I: Connect either an Error LED between + and D/I for a simple error indication.
The Error LED will be driven with 10 mA constant current.
Or connect communication interface (Tool4Cool® gateway or customer controller like display) between D/I and C.
- P, C Connect a battery protection resistor to select the required battery cut out value.
See table at chapter 6, **Battery programming**, on page 9.
- C+T Connect either a mechanical thermostat, a mechanical thermostat in series with a speed programming resistor or a NTC temperature sensor.
See chapter 7, **Speed control modes** on page 12.

101N0510

- L, N Main supply voltage, voltage range 100-240 V AC 50/60 Hz
- A, C Lamp connection (max. 5 W, connect always 12 V)

**3.4
Wire dimensions
101N0212, 101N340,
101N0420, 101N0510,
101N0650**

Size		Max length* 12 V DC operation		Max. length* 24 V DC operation	
AWG Gauge	Cross section mm ²	ft.	m	ft.	m
12	2.5	8	2.5	16	5
11	4	13	4	26	8
10	6	20	6	39	12
8	10	33	10	66	20

* Length between battery and electronic unit

Wire dimensions AC
Cross section min. 0.75 mm² or AWG 18

**Wire dimensions
101N0390**

Size		Max length* 12 V DC operation		Max. length* 24 V DC operation	
AWG Gauge	Cross section mm ²	ft.	m	ft.	m
10	6	8	2.5	16	5

* Length between battery and electronic unit

The above mentioned maximum wire length ensures sufficient low voltage drop during start and operation. Thinner wires may cause unintended low voltage battery cut-outs due to low voltage at the electronic unit, despite the voltage at the battery still being in an acceptable range.

MENU OVERVIEW

4.1 User interface

Operation of the Compressor control unit can be done through the PC software Tool4Cool®. An example of the menu structure is shown below. It may vary depending on the controller model.

On the following pages each separate menu is explained in detail. For installation and operation of Tool4Cool®, please refer to Chapter 15 **Installation of the software** on page 26.

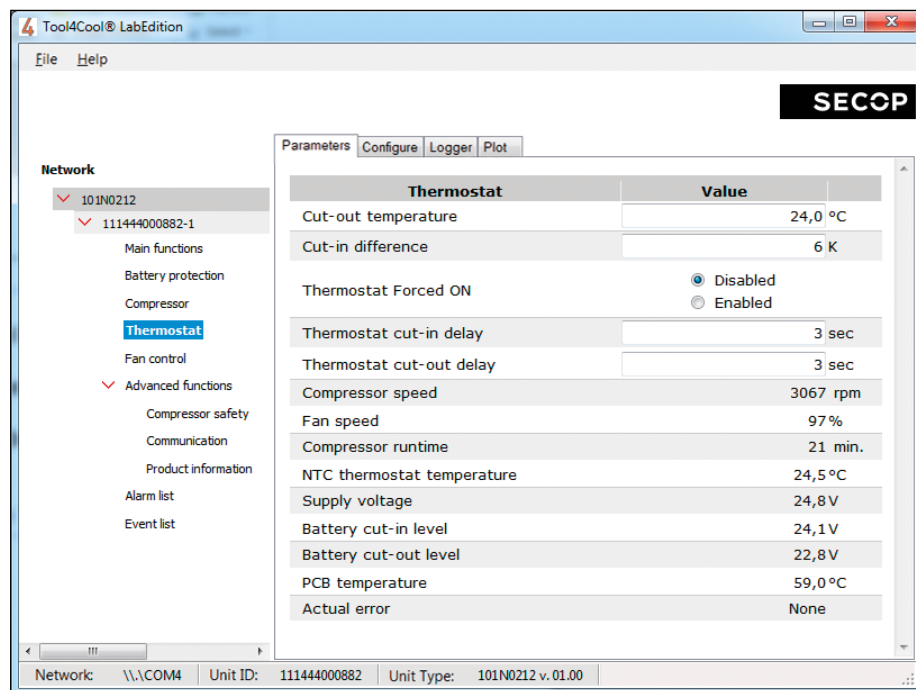

4.2 Operation

The Tool4Cool® software enables the user to observe and document certain aspects of the compressor operation via the controller. The output of the software is in the form of data logs and plots.

Using Tool4Cool® the user can also change the settings of the controller parameters, and copy settings from one controller to another.

5. PARAMETERS

Description of parameters

Main Switch Function

In order to start and stop the compressor the Main Switch can be set to ON or OFF. OEMs making an interface with custom design electronics via Modbus must be able to control the CCU ON/OFF via the Main Switch (CCU = Compressor Control Unit).

ON: All functions are active.

OFF: All main functions are inactive, however

- Battery monitoring active
- NTC temperature sensor monitoring active
- PCB inverter temperature monitoring active

Settings

Name	Default	Max. value	Min. value	Step	Unit
Main switch	ON	ON	OFF	1	-
Default main switch	ON	OFF	ON	1	-

Beside the "Main Switch" parameter a "default main switch" parameter is available. This parameter defines, how the main switch will be set after a power supply interruption.

For standalone systems without a customer specific controller (e.g. display) it's recommended to have this "default main switch" set to 1 (ON) which is also the default. This way the unit will automatically continue to run after a power interruption.

For systems using a customer specific controller (e.g. display), it should be set to 0 (OFF) to ensure, that the compressors stays off even after a power down/up, if the communication line is interrupted.

6. BATTERY PROTECTION

The battery protection prevents permanent damage to the battery by discharge.

The setting range is 9-17 V DC for 12 V DC systems, and 19 to 27 V DC for 24 V DC systems. The cut out values and cut in differences can be set individual for 12 V systems and 24 V systems. Battery protection function is disabled in Solar controller 101N0420 (fixed range 10 to 45 V DC).

If the voltage remains below the cut-out voltage for the time specified in the parameter "Cut-out delay" (default 3s), compressor and fan are stopped.

Compressor and fan are stopped immediately, if the voltage drops below 8 V in 12 V systems and below 18 V in 24 V systems (critical stop).

If Solar mode is enabled, the electronic will be able to run over the entire input voltage range (9-32 V), without stopping between 12 V and 24 V range.

Tolerances are ± 0.30 V DC.

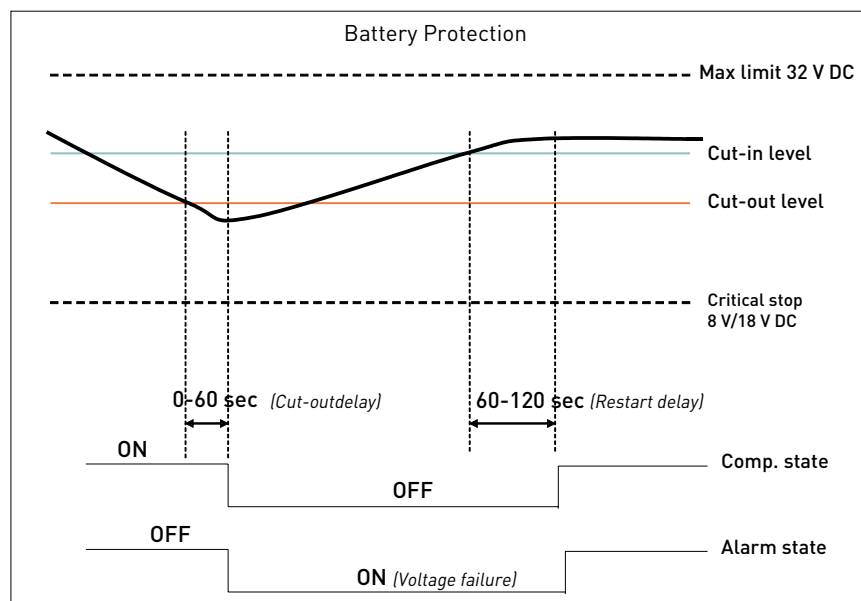

Settings

Name	Default	Max value	Min value	Step	Unit
Battery cutout level 12 V DC	10.4	17	9	0.1	Volt
Battery cut-in diff. 12 V DC	1.3	10	0.5	0.1	Volt
Battery cut-out level 24 V DC	22.8	32	19	0.1	Volt
Battery cut-in diff. 24 V DC	1.3	10	0.5	0.1	Volt
Battery Solar mode on/off	Disable	Enable	Disable	-	-
Cutout delay	3	60	0	1	Seconds

Measurements

Name	Note	Unit
Voltage cut-out level	Only show in Solar Mode	Volt
Battery cut-in level	In Solar Mode change text to voltage cut-in level	Volt
Supply voltage	Measured on + and - terminals	Volt

6.1 Solar mode

In order to let the compressor run on solar panels, the solar mode should be enabled. The solar mode can be enabled either with Tool4Cool® or with a 220 kOhm resistor between C and P.

With solar mode enabled, the battery protection settings will not stop the compressor between 12 V and 24 V voltage range, but let it run over the entire voltage range from 9 to 32 V DC.

The above mentioned is not valid for dedicated Solar controller 101N0420 which can run from 10 to 45 V DC.

Settings

Name	Default	Max value	Min value	Step	Unit
Battery Solar mode on/off	Disable	Enable	Disable	-	-

6.2 Battery programming resistor

To program the battery cut out value, either Tool4Cool® can be used or a resistor can be connected between C and P. See R2 in chapter 3.1 and 3.2, wiring diagrams on page 5.

Resistor (R2) kΩ	12 V cut-out [V]	12 V cut-in [V]	12 V max. [V]	24 V cut-out [V]	24 V cut-in [V]	24 V max. [V]
0	9.6	10.9	17.0	21.3	22.7	31.5
1.6	9.7	11.0	17.0	21.5	22.9	31.5
2.4	9.9	11.1	17.0	21.8	23.2	31.5
3.6	10.0	11.3	17.0	22.0	23.4	31.5
4.7	10.1	11.4	17.0	22.3	23.7	31.5
6.2	10.2	11.5	17.0	22.5	23.9	31.5
11	10.5	11.8	17.0	23.0	24.5	31.5
14	10.6	11.9	17.0	23.3	24.7	31.5
18	10.8	12.0	17.0	23.6	25.0	31.5
24	10.9	12.2	17.0	23.8	25.2	31.5
33	11.0	12.3	17.0	24.1	25.5	31.5
47	11.1	12.4	17.0	24.3	25.7	31.5
82	11.3	12.5	17.0	24.6	26.0	31.5
220	9.6	10.9				31.5

Not valid for Solar controller 101N0420 (10 to 45 V DC)

7. COMPRESSOR SPEED

The speed and thereby the capacity of the compressor is set using the **Requested speed** parameter. During start up, the compressor runs at a lower speed, **Start speed** (fixed 2500 rpm), than Requested speed. The duration of the period running at **Start speed** is set using the **Start time** (min. 30 sec, adjustable to 0 sec in 101N0420) parameter.

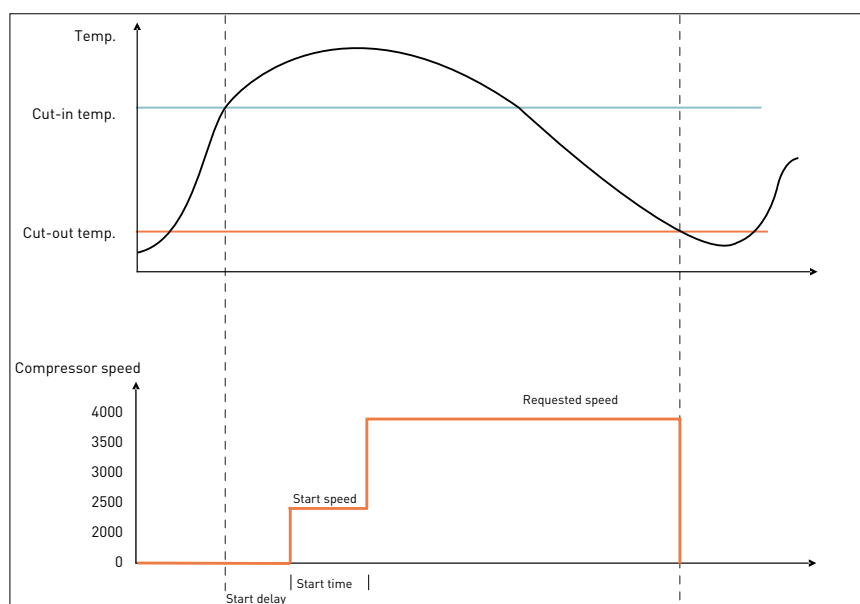

If the compressor speed drops below the minimum or exceeds the maximum speed, the compressor will stop and an alarm **Min speed failure** or **Max. speed failure** will be sent. The compressor will try to restart after the set **Restart time**. The **Restart time** default is 60 sec. The fans will continue to run.

**7.1
Compressor speed
control modes**

- The speed and capacity can be controlled in four ways:
- 1) mechanical thermostat with speed control resistor
 - 2) mechanical thermostat and speed set via Tool4Cool® / communication interface
 - 3) NTC and ECO speed set via Tool4Cool® / communication interface
 - 4) NTC and fixed speed set via Tool4Cool® / communication interface

**7.1.1.1
Speed control Mode 1
101N0212, 101N0650,
101N0510**

Mechanical Thermostat and Resistor Speed

In Speed control mode 1, the speed can be set via an external resistor in series with the mechanical Thermostat (see chapter 3, page 5, **Wiring diagram**). Alternatively, a constant current or a PWM signal (open collector, 5kHz +-5%) can be used to control the speed. For details of the speed, please refer to the following table:

	Motor speed [rpm]	Resistor R1 [Ohm]
101N0212 101N0510 101N0650	2000	0
	2500	277
	3000	692
	3500	1523

**7.1.1.2
Speed control Mode 1
101N0340, 101N0390,
101N0420**

Mechanical Thermostat and Resistor Speed (no resistor in AEO mode)

In Speed control mode 1, the speed can be set via an external resistor in series with the mechanical Thermostat (see chapter 3, page 5, **Wiring diagram**). Alternatively, a constant current or a PWM signal (open collector, 5kHz +-5%) can be used to control the speed.

If no resistors are connected between C and T, speed control is done by AEO. The AEO function can be adapted via four setpoint parameters:

- **AEO Runtime setpoint:**
The target runtime for the compressor during cut-in
- **AEO Start speed at power up:**
The start speed of compressor in AEO mode, overruled by fixed speed with 2500 rpm for 30 sec
- **AEO Max. ramp up time:**
The maximum time that the speed is ramping up before reaching maximum speed for the compressor (3500 rpm for 101N0340 and 4400 rpm for 101N0390)
- **AEO Reduction of next start speed:**
The parameter defines how much the next start speed shall be reduced at next thermostat cut-in

For details of the speed, please refer to the following tables on the next page.

101N0340 101N0420 with AEO	Motor speed [rpm]	Resistor R1 [Ohm]
	AEO	0
	2000	173
	2500	450
	3000	865
	3500	1696

101N0390 with AEO	Motor speed [rpm]	Resistor R1 [Ohm]
	AEO	0
	2500	203
	3100	451
	3800	867
	4400	1700

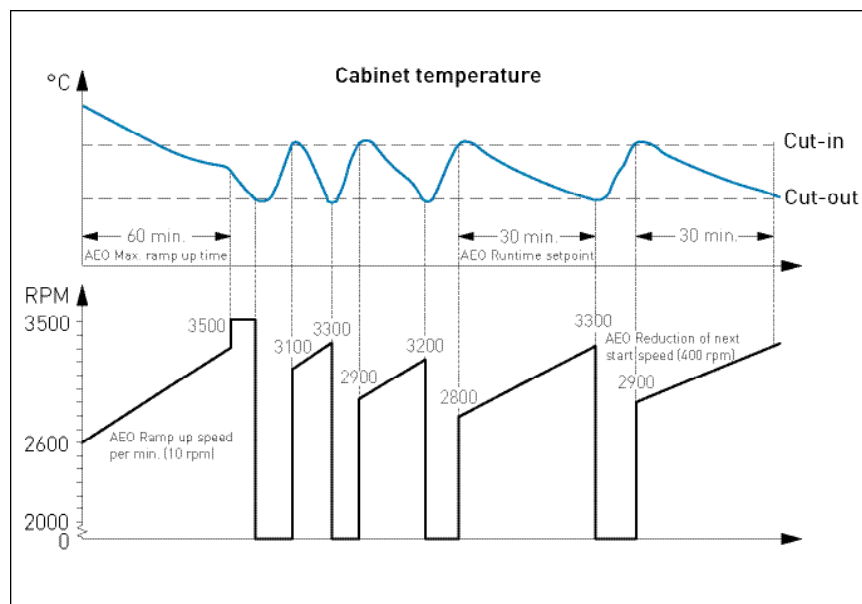

**7.1.2
Speed control Mode 2**

Mechanical Thermostat and Tool4Cool® Speed

In Speed control mode 2, the speed can be set via Tool4Cool® or any customer specific controller (e.g. a display). To set the compressor speed, enter the required speed into the field "requested compressor speed".

The Compressor On / Off state is still controlled via a mechanical thermostat. Alternatively it can also be controlled via Tool4Cool® or any customer specific controller (e.g. a display). This would be done via the "thermostat forced on" parameter.

**7.1.3
Speed control Mode 3**

NTC and ECO Speed

"NTC and ECO speed set via Tool4Cool® / communication interface" would be used if a NTC is used to control the temperature inside the cabinet. This is the most advanced function of the new controllers. The compressor speed is automatically adapted to the current cooling requirement.

Operation in ECO mode reduces energy consumption and noise by controlling compressor speed as a function of temperature.

The Eco Temperature is automatically calculated to be in the middle between cut in temperature and cut out temperature:

- when operating below ECO temperature, compressors run at the set ECO speed (often 2000 rpm)
- when operating above ECO temperature, the compressors run at Requested speed (often 3500 rpm)

The temperatures can be adjusted in the "Thermostat" section within Tool4Cool®.

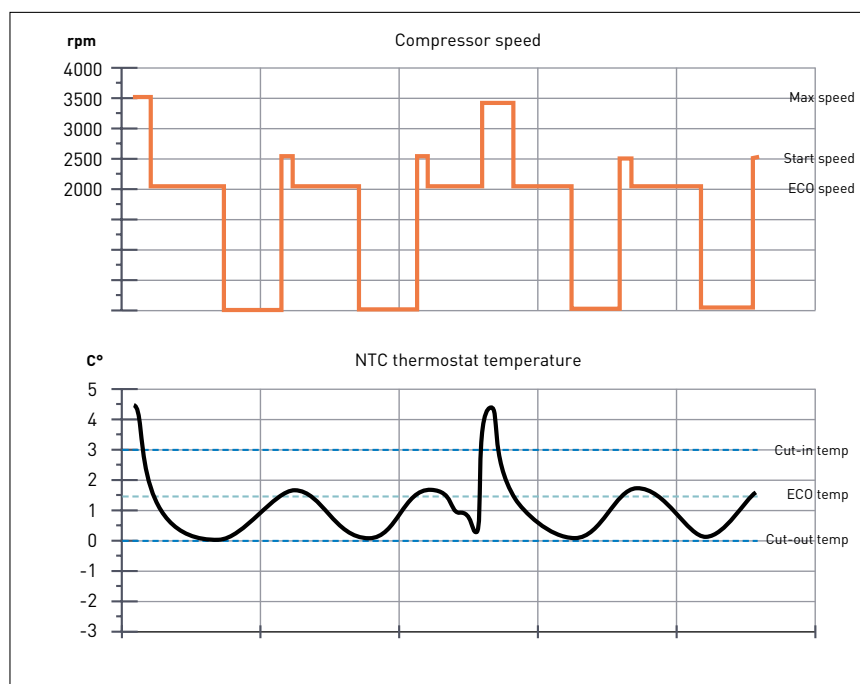

**7.1.4
Speed control Mode 4**

NTC and fixed speed

NTC with fixed speed is used, if the ECO function is not required. The compressor is running with the fixed speed, set via Tool4Cool®.

The NTC temperatures for cut in and cut out can be set in the thermostat section within Tool4Cool®.

7.2 Compressor min. and max. speed protection

Settings 101N0212/101N340/101N420/101N510/101N650

Name	Default	Max value	Min value	Step	Unit
Requested speed	2000	3500	2000	10	rpm
Start delay	2	240	0	1	Seconds
Start speed	2500	2500	2500	1	rpm
Start time	30	240	30	1	Seconds

Settings 101N0390

Name	Default	Max value	Min value	Step	Unit
Requested speed	2500	3500	2000	10	rpm

Measurement

Name	Description	Step	Unit
Compressor speed	Real-time compressor speed (+/- 10 %)	1	rpm

The compressor is protected against operation below minimum speed. Lubrication of the compressor will be very poor at excessively low speed and therefore low speed operation would lead to destruction of the compressor. Speed limits are: min 1850 rpm; max speed 3750 rpm.

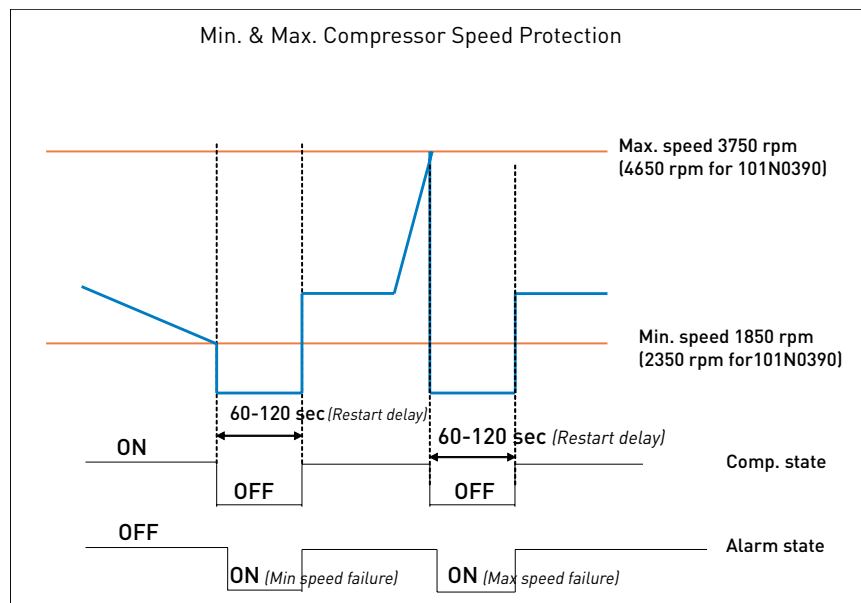

CONDENSER FAN

Condenser fan

The fan is synchronized with the compressor operation.

Start and stop delays can be set up as a function of the state of the **thermostat**.

Furthermore, the fan can be set to run continuously (forced ON operation).

Some fan defects are detectable, and are displayed in the parameter **Error**.

The fan start and stop delays start after the thermostat delays have passed. Please see chapter 9.2 on page 15, **Thermostat delays**.

Settings

Name	Default	Max value	Min value	Step	Unit
Fan start delay	0	240	0	1	Seconds
Fan stop delay	0	240	0	1	Seconds
Fan forced ON	OFF	ON	OFF	1	-

Measurements

Name	Description	Step	Unit
Fan speed	Actual fan speed	-	%

9. THERMOSTAT

9.1 Thermostat type

Two types of thermostat can be utilized for temperature control.

9.1.1 Electronic thermostat (NTC sensor)

The electronic thermostat provides active temperature control. With an NTC sensor the cabinet temperature can be measured constantly by the compressor electronic. If a customer controller (display) is used, it can just sent the desired temperature to the compressor controller and the compressor controller will regulate the compressor operation automatically according to the demand. Disconnected sensor error alarm (**NTC sensor failure**) is sent when the measured temperature is $> 85\text{ }^{\circ}\text{C}$. Short circuited sensor error alarm (**NTC sensor failure**) is sent when the measured temperature $< -50\text{ }^{\circ}\text{C}$.

9.1.2 Mechanical thermostat

A mechanical ON/OFF thermostat can be connected at terminals C & T. No detection of faulty thermostat is provided when an ON/OFF thermostat is used.

9.2 Thermostat delays

In order to prevent the compressor from accidentally starting and stopping due to a flickering Thermostat, a delay can be added. This delay can be especially useful on bumpy roads. The default on delay is one second, the default off delay is zero second.

In general, there are three on- and off-delays built into the electronic:

- a) Thermostat on- and off-delay
- b) Compressor on- and off-delay
- c) Fan on- and off-delay

The compressor is started after the thermostat has closed and thermostat on-delay plus compressor on-delay have elapsed.

The fan is started after the thermostat has closed and thermostat on-delay plus fan on-delay have elapsed.

A Thermostat on and off event is only logged, once the corresponding Thermostat delay is elapsed. Therefore it is generally recommended, to set the thermostat delay as high as acceptable for the user.

Settings

Name	Default	Max value	Min value	Step	Unit
Cutout temperature	4	+ 40	-40	1	Celcius ($^{\circ}\text{C}$)
Difference	2	15	1	1	Kelvin (K)
Forced ON	OFF	ON	OFF	1	-

Measurements

Name	Description	Step	Unit
Runtime	Runtime is provided to record cooling-time (thermostat cut-in period). The runtime is updated during cooling, starting with 0 at start of each cooling period. During cooling OFF (Thermostat cut-out), the Runtime parameter will show the time for the last cooling period. Runtime is reset at the beginning of a cooling ON period, and at power-up.	1	Minutes
Actual temperature	Real-time air temperature when a NTC sensor is used. When a mechanical thermostat is used, only thermostat status ON or OFF is displayed.	-	$^{\circ}\text{C}$

10. COMMUNICATION

Lost Communication

In a network system with custom designed interface modules acting as master on the Modbus, it is desirable to stop the compressor from running when communication to the master is lost.

If communication is lost it will not be possible for the customer to stop the compressor as long as cooling is requested.

The function will stop the compressor after a certain time (Communication time out), when there is no contact to the master controller. The stop is realized through the MainSwitch. The Main Switch will be set to OFF.

If the power gets disconnected, the main switch will be set to "Default Main Switch after power up" (see section Main Switch on page 5).

If a customer specific controller (e.g. display) is used, it is recommended to set "Default Main Switch after up" to 0 (OFF) and "Set Main Switch to OFF when communication timeout occurs" to 1 (ON).

Bus addresses

The node number is the address of the electronic. If multiple compressor electronics are used with one customer controller in one network, each compressor electronic must have its unique Node Number.

Protection code

A coded privacy function protects customers' settings from being read by third parties. The code must be verified by entering twice.

Settings

Name	Default	Max value	Min value	Step	Unit
Bus address	1	247	1	1	-
Communication timeout	900	7200	15	1	Seconds
Protection code	0	9999	0	1	-

Mesurements

Name	Default	Max value	Min value	Step	Unit
Protection status	0	1	0	1	on/off

PRODUCT INFORMATION

Labels on electronic units consist of a 2D Data Matrix Code area and a number of lines with information. The 2D Data Matrix Code is always built up with 62 characters containing information about type, code number, product version, product revision, unit ID, supplier, part number and text.

Text information on the label:

Line 1: ID: PLYYWWssssss (unique number)

Line 2: Date: YYWW

Line 3: Ver.: VV

Line 4: Text: text

Meaning:

PL Production location, 01 ... 99

YY Year, 12 = 2012

WW Week number, 01 ... 52

ssssss Serial number, 000001 ... 999999

VV Version, 00 ... 99

Settings

Name	Description
Unit name	Possible to fill in customer name for the unit when presented in PC software program Tool4cool®.

Measurements

Name	Description
Product code no.	Secop product code number
Firmware version	Controller software version
Production date	Secop production date

ERROR AND EVENT LOG

12.1 Actual Error

The alarm function notifies the user when an error arises in the system, and implements measures which prevent damage to the refrigeration system. This parameter is on view in all parameter groups.

Output

Name	Description
Actual error	0 = No error 1 = Voltage failure 2 = Fan failure 3 = Motor failure 4 = Speed failure 5 = Thermal failure 6 = NTC sensor failure 7 = Communication error

These error codes can also be read out via an Error LED, connected between + and D/I. See Chapter 3 on page 5.

12.2 Error log

In order to assist in service and fault situations, an error log is implemented in ECU, the log is read out via Tool4Cool®. The log contains Errors and the sequence of their occurrence. Additionally, they are linked to the Event log.

Each error contains the following information:

- Time of occurrence related to compressor power up, with 1 sec as sample time
- The sequence of occurrence (Error list reference)
- Error main description
- SubError description
- Number of occurrence

possible to clear the error log via a clear function.

12.3 Event log

In order to assist in service and fault situations, an event log is implemented in ECU, the log is read out via Tool4Cool®. The log contains parameters and events when parameter changes and on Power up.

Each event contains the following information:

- Time of occurrence related to compressor power up, with 1 sec as sample time
- The sequence of occurrence (Event list reference)
- Parameter/Event description
- The value of the parameter
- Number of occurrence (when no value is related to the parameter)
- The value of the parameter which caused the failure (if connected to a parameter); it is possible to clear the event log via a clear function.

13.

INVERTER TEMPERATURE (PCB)

The controller overheating protection system ensures that the controller does not operate at extremely high temperatures, because under these conditions the quality of the soldered joints will be endangered.

When the unit reaches 110 °C the system will shut down and an alarm error (**Alarm 6: Thermal failure**) will be sent.

The system restarts automatically after the temperature has dropped below 100 °C. Hereafter the set delay **Compressor restart delay** must be terminated. The default duration is 60 sec.

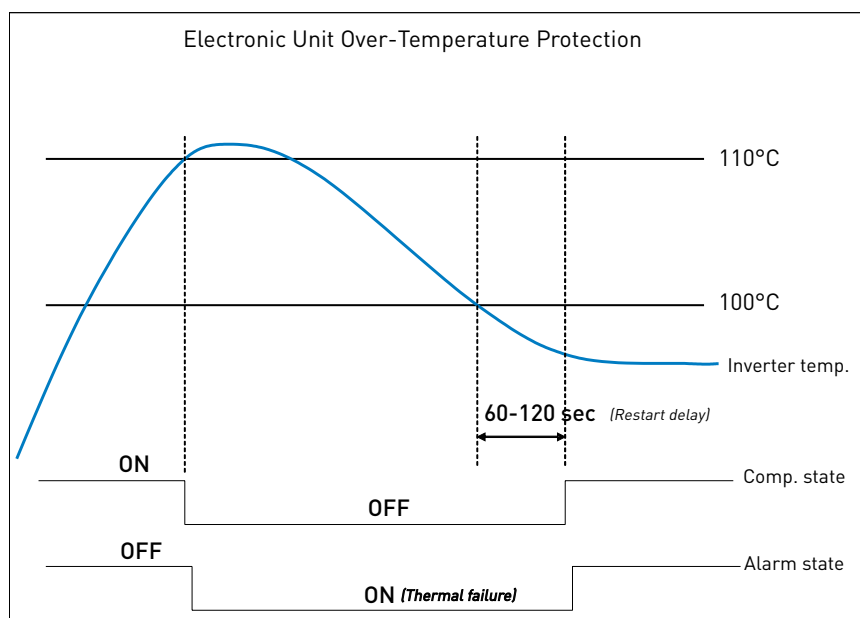

14. ORDERING

	Model	Code number	Description
Compressors	BD35F	101Z0200	standard version
	BD35F	101Z0204	inch connectors
	BD35F-B	101Z0205	noise improved version for busses and trucks
	BD35F-HD	101Z0206	heavy duty version for trucks with chassis mounted
	BD50F	101Z1220	standard version
	BD50F	101Z0203	inch connectors
	BD80F	101Z0280	standard version
	BD35K	101Z0211	standard version
	BD80CN	101Z0403	standard version
	BD100CN	101Z0401	standard version
	BD250GH.2	101Z0406	standard version, 2nd generation improved in cooling capacity and COP
Single-Pack	Electronic unit Standard, 12/24 V DC	101N0212	controller
	Electronic unit AEO, 12/24 V DC	101N0340	controller
	Electronic unit High Speed, 12/24 V DC	101N0390	controller
	Electronic unit Solar, 10-45 DC	101N0420	controller
	Electronic unit AC/DC, 12/24 V DC, 100-240V AC 50/60Hz	101N0510	controller
	Electronic unit Automotive, 12/24 V DC	101N0650	controller
	Temperature sensor, 470 mm, spade connectors	105N9612	accessories
	Temperature sensor, 1000 mm, spade connectors	105N9614	accessories
	Temperature sensor, 1500 mm, spade connectors	105N9616	accessories
Secop One Wire/LIN gateway with cables & driver	105N9501	accessories	
Industrial-Pack (I-Pack)	Electronic unit Standard, 12/24 V DC	101N0213	controller, 30 pcs
	Electronic unit AEO, 12/24 V DC	101N0341	controller, 30 pcs
	Electronic unit High Speed, 12/24 V DC	101N0391	controller, 30 pcs
	Electronic unit Solar, 10-45 DC	101N0421	controller, 30 pcs
	Electronic unit AC/DC, 12/24 V DC, 100-240V AC 50/60Hz	101N0511	controller, 28 pcs
	Electronic unit Automotive, 12/24 V DC	101N0651	controller, 30 pcs
	Temperature sensor, 470 mm, spade connectors	105N9613	accessories, 200 pcs
	Temperature sensor, 1000 mm, spade connectors	105N9615	accessories, 100 pcs
	Temperature sensor, 1500 mm, spade connectors	105N9617	accessories, 100 pcs
Software Package	Tool4Cool® LabEdition	free of charge	www.secop.com/solutions/application-detail/variable-speed-drive-software-tool4cool/
Driver	Virtual COM Port Driver for Wire/LIN Gateway (Future Technology Devices International Ltd.)		www.ftdichip.com/Drivers/VCP.htm

ONE WIRE/LIN GATEWAY

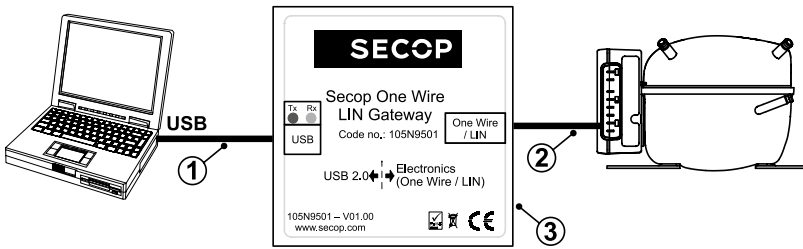

Gateway **105N9501** package contains:

Pos.	Description
1	USB 2.0 A/B Cable
2	One Wire/LIN Gateway Communication Cable 105N9532
3	Secop One Wire/LIN Gateway Length, Height: 55 mm / Width: 82 mm / Depth: 80 mm



Please install the latest Virtual COM Port Driver from Future Technology Devices International Ltd.: www.ftdichip.com/Drivers/VCP.htm

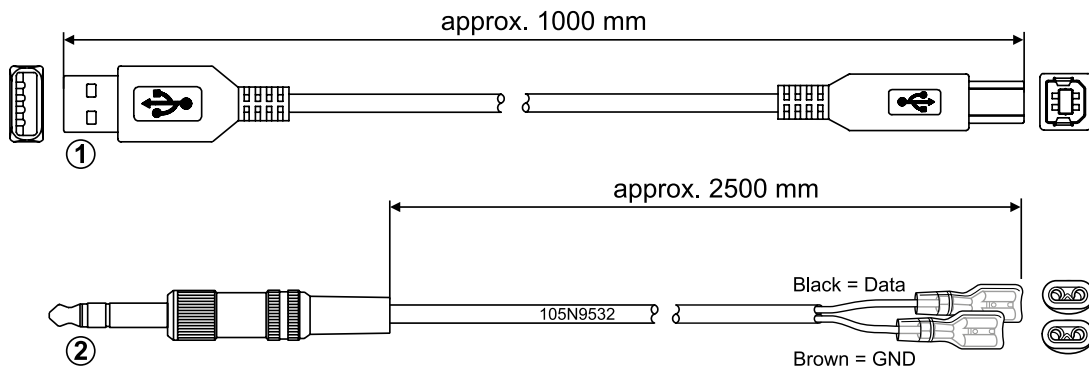

MODBUS Parameter identification						
Register number	Group name & parameter text	Setting or measurement	Default setting	Min. Value	Max. value	Unit shown in T4C
Main functions. Menu level 1						
35401	Main switch	Setting	ON	OFF	ON	
35402	Default Main switch	Setting	ON	OFF	ON	
Battery protection. Menu level 1						
35324	Battery cut-out level 12 V DC	Setting	10.4	9	17	V
35325	Battery cut-in difference 12 V DC	Setting	1.3	0.5	10	V
35326	Battery cut-out level 24 V DC	Setting	22.8	19	32	
35327	Battery cut-in difference 24 V DC	Setting	1.3	0.5	10	V
35303	Battery cut-out delay	Setting	3	0	600	sec
35330	Solar Mode	Setting	Disable	Disable	Enable	
35304	Voltage cut-out level	Measurement				V
	Battery cut-in level	Measurement				V
35400	Supply voltage	Measurement				V
Compressor. Menu level 1						
35101	Speed control mode	Setting	1	1	4	
35001	Requested compressor speed	Setting	2000 rpm	2000 rpm	3500 rpm	rpm
35111	Requested ECO speed	Setting	2000 rpm	2000 rpm	3500 rpm	rpm
35002	Compressor start delay	Setting	2	0	240	sec
35029	Compressor stop delay	Setting	0	0	240	sec
35004	Compressor start speed	Setting	2500 rpm	2500 rpm	2500 rpm	rpm
35005	Compressor start time	Setting	30	30	240	sec
35151	AEO Runtime setpoint	Setting	30	15	240	min.
35152	AEO Start speed at power up	Setting	2600	2000	3500	rpm
35153	AEO Max. ramp up time	Setting	60	15	150	min.
35154	AEO Reduction of next start speed	Setting	300	100	1000	rpm
35098	Compressor speed	Measurement				rpm
35113	Compressor runtime	Measurement				min.
Thermostat. Menu level 1						
35102	Cut-out temperature	Setting	4	-40	40	°C
35103	Cut-in difference	Setting	2	1	15	K
35104	Thermostat Forced ON	Setting	Disabled	Disabled	Enabled	
35403	Thermostat cut in delay	Setting	2	0	90	sec
35404	Thermostat cut out delay	Setting	0	0	90	sec
35200	NTC thermostat temperature / Thermostat	Measurement				°C
Fan control. Menu level 1						
35203	Fan start delay	Setting	0	0	240	Sec
35204	Fan stop delay	Setting	0	0	240	Sec
35205	Forced ON	Setting	Disabled	Disabled	Enabled	
35300	Fan speed	Measurement		0	100	%
Compressor safety. Menu level 2. Advanced functions						
35003	Compressor restart time	Setting	60	60	120	sec
Communication. Menu level 2. Advanced functions						
35901	Node number	Setting	1	1	250	
35903	Set Main Switch to OFF when communication timeout occurs	Setting	0	0	1	
35904	Communication timeout	Setting	900	15	7200	sec
35905	Protection code	Setting	0	0	9999	

MODBUS Parameter identification	
EEPROM	Note
Main functions. Menu level 1	
	See also "default main switch".
X	Defines the value of mainswitch parameter 35401 after reset.
Battery protection. Menu level 1.	
X	Hide in Solar Mode.
X	In Solar Mode change from setting to measurement. Change text from Battery cut-in difference to Voltage cut-in difference.
X	Hide in Solar Mode
X	In Solar Mode change from setting to measurement. Change text from Battery cut-in difference to Voltage cut-in difference.
X	Valid during start up and normal operation.
X	Voltage range is 9.6 to 32 V DC when enabled.
	Only show in Solar Mode.
	In solar mode change text to Voltage cut in level.
	Measured on + and - terminals.
Compressor. Menu level 1	
X	1 = Mech thermostat and speed via resistor 2 = Mech thermostat and speed via T4C 3 = NTC and ECO mode 4 = NTC and speed via T4C
X	Overruled by resistor in series with thermostat in speed mode 1. Hide in speedmode 1.
X	Overruled by resistor in series with thermostat in speed mode 1.
X	The time that the compressor should wait after sp voltage above min stop.
X	The time that the compressor should wait after sp voltage above min stop.
	Fixed 2500 rpm.
X	Adjustable to min. 0 sec in 101N0420
X	The target runtime for the compressor during cut-in
X	The start speed of compressor in AEO mode, overruled by fixed speed with 2500 rpm for 30 sec
X	The maximum time that the speed is ramping up before reaching maximum speed for the compressor (3500 rpm for 101N0340 and 4400 rpm for 101N0390)
X	The parameter defines how much the next start speed shall be reduced at next thermostat cut-in
	Cut-in time will show the time for the last cooling period (thermostat cut-in period). Compressor runtime is reset at every start of cooling ON period.
Thermostat. Menu level 1	
X	
X	
X	
X	Thermostat filter, e.g. For Tilt sensor filtering.
X	Thermostat filter, e.g. For Tilt sensor filtering.
	Real time air temperature when a NTC sensor is used. When a mechanical thermostat is used, only thnermostat status ON or OFF is displayed.
Fan control. Menu level 1	
X	Delay compared to thermostat status
X	Delay compared to thermostat status
X	
Communication. Menu level 2. Advanced functions	
X	The time that the unit should wait before attempting a restart, after an error has occurred.
Communication. Menu level 2. Advanced functions	
X	Can be changed without restarting the electronic unit.
X	0 = Function disabled. 1 = Set Main Switch to OFF when communication timeout occurs.
X	
X	Writing: When locking the unit, the code should be written twice to verify. When unlocking the unit, the code should only be written once.

MODBUS Parameter identification						
Register number	Group name & parameter text	Setting or measurement	Default setting	Min. Value	Max. value	Unit shown in T4C
Product information. Menu level 2. Advanced functions						
	Unit name	Setting				Characters
	Product code	Measurement	101N0XXX	0	0	0
	Software version	Measurement	01.00	0	999	
	Production date	Measurement	XX-YY	0	99999	1
BD status.						
35100	Actual error	Measurement		0	8	
35868	Clear alarmlist	Setting	0	0	1	
35867	Clear eventlist	Setting	0	0	1	
35099	PCB temperature	Measurement				°C

MODBUS Parameter identification	
EEPROM	Note
Product information. Menu level 2. Advanced functions	
X	30char, Assign custom name of the unit
	XXX: Day of year Y: Year
BD status.	
	0 = No error 1 = Voltage failure 2 = Fan failure 3 = Motor failure 4 = Speed failure 5 = Thermal failure 6 = NTC sensor failure 7 = Communication error
	Clearing of alarmlog. Only the one for endusers.
	Clearing of eventlog. Only the one for endusers.
	The electronic unit has the following settings: Cut-out = 26368 (110°C) Cut-in = 31424 (100°C)

INSTALLATION OF SOFTWARE

Install and configure software

- 1) Visit: <https://www.secop.com/solutions/application-detail/variable-speed-drive-software-tool4cool/> and download the latest Tool4Cool® version
- 2) Open the download.

SETTING THE
STANDARD

SECOP



Tool4Cool® Software Installation
(please click) **Version 2.01**

Note: If above link fails to run setup, please run executable *setup.exe* in installation folder i.e. default folder of CD.

Minimum system requirements:

- PC with min. 1 GHz Intel Pentium III processor or equivalent, and min. 500MB available memory
- PC operating system: Microsoft Windows XP, Windows Vista or Windows 7 with the latest patches and updates for Windows released by Microsoft.
- .NET Framework with the latest patches and updates for .NET Framework released by Microsoft (www.microsoft.com/.NET). If .NET is not installed and if the PC is connected online Tool4Cool® will try to install it.

PDF Files:

- [Tool4Cool® Software Disclaimer \(please read\)](#)
- [Tool4Cool® Operating Instructions](#)

Adobe® Acrobat Reader



3. Double-click **Tool4Cool® Software Installation**. Run the file setup.exe. Then follow the instructions in the **Setup Wizard**.

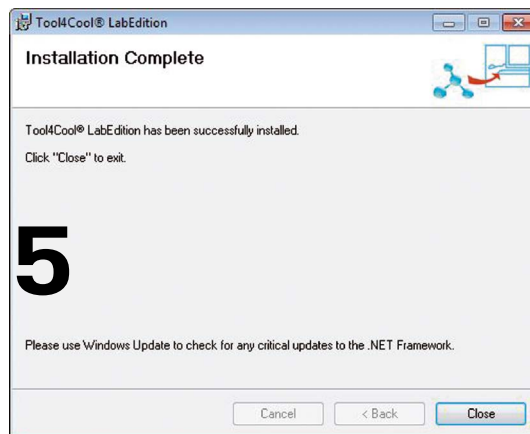
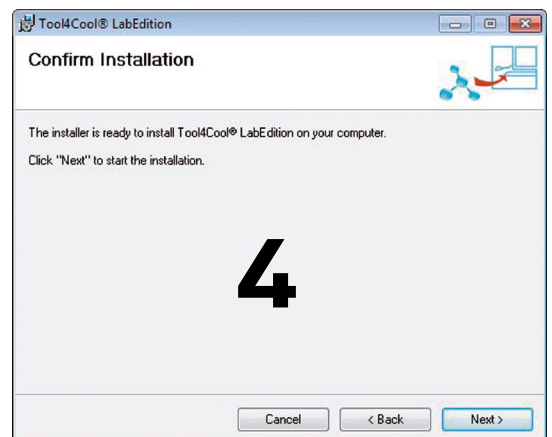
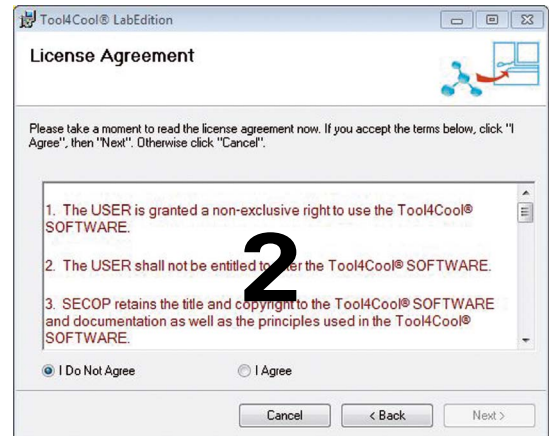
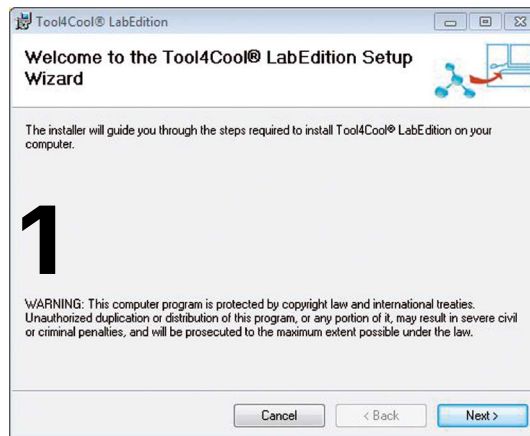

For detailed instructions please refer to **Tool4Cool® LabEdition Operating Instructions**. This manual can be downloaded from the Tool4Cool® homepage:

Latest **Virtual COM Port Driver for Wire/LIN Gateway** from Future Technology Devices International Ltd.: <http://www.ftdichip.com/Drivers/VCP.htm>

Install product key

1. Start Tool4Cool® LabEditon by double clicking on the icon on the desktop:



2. Select Help in the menu bar.

3. Select Product Keys from the drop-down menu:

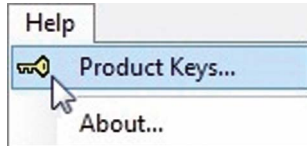

4. This dialog box will open:

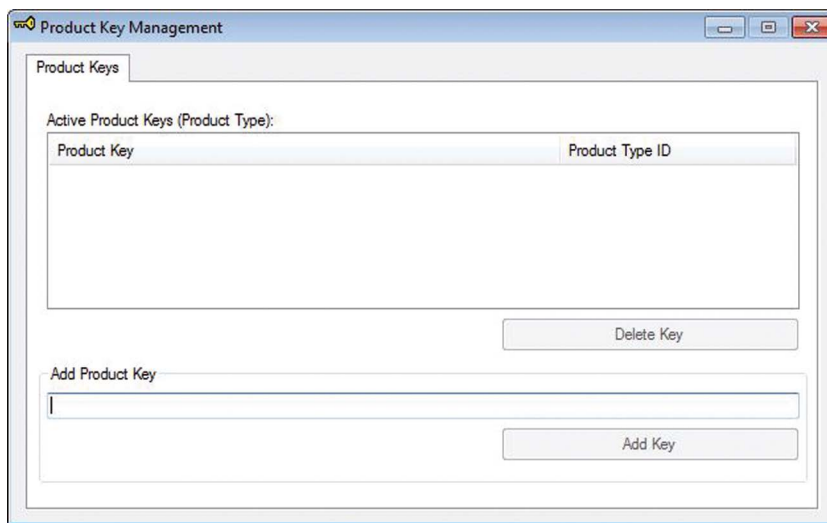

In the Add Product Key field, type the Product Keys shown on the Tool4Cool® Homepage:

<https://www.secop.com/solutions/application-detail/variable-speed-drive-software-tool4cool/>

Click the Add Product Key button, to add it to the list.

The Product Key is now listed in the Active product keys list.

Connect network

1. Select File in the menu bar.
2. Select Connect Network in the drop-down menu:

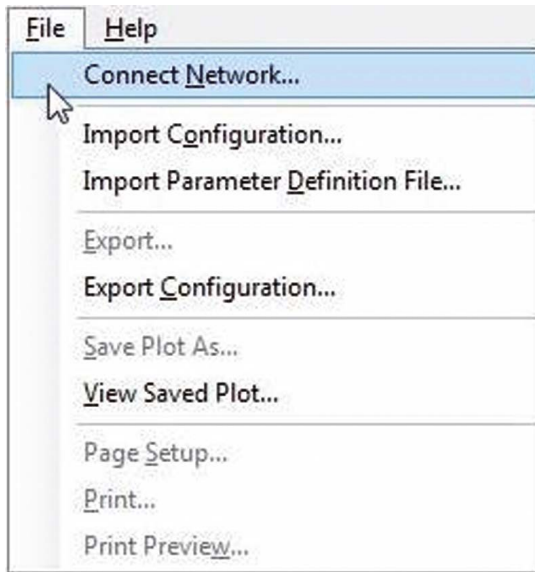

3. This dialog box will open:

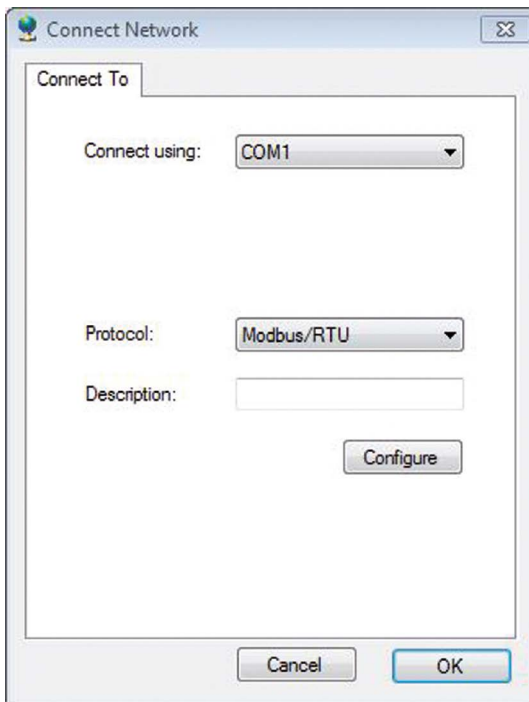

In the **Connect using** field, select the COM port to which the gateway is connected.

Press the configure button and select:

- first network node = 1
- last network node = 3
- refresh rate = 3

Close the configure network dialog with OK.

Close the connect network dialog with OK.

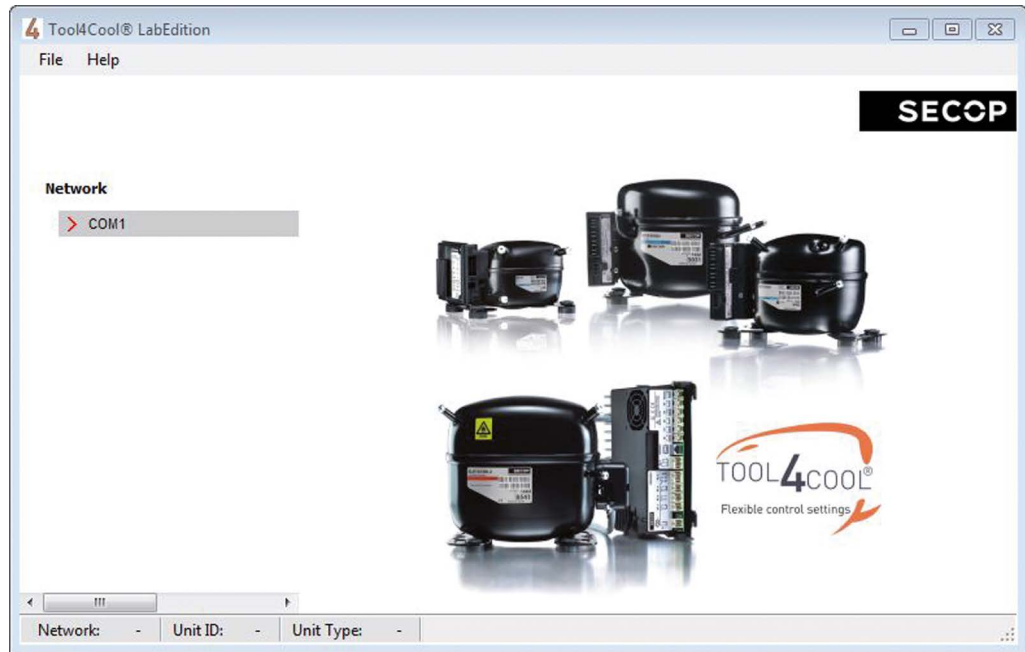

Wait a short time. The LEDs on the gateway will flash, then a red arrow will appear in front of the description (COM1).
The controller is now accessible via Tool4Cool®.

Ready to operate

Click the red arrows to view the controller and its parameter groups:



Click a parameter group name to view details to the right of the screen:

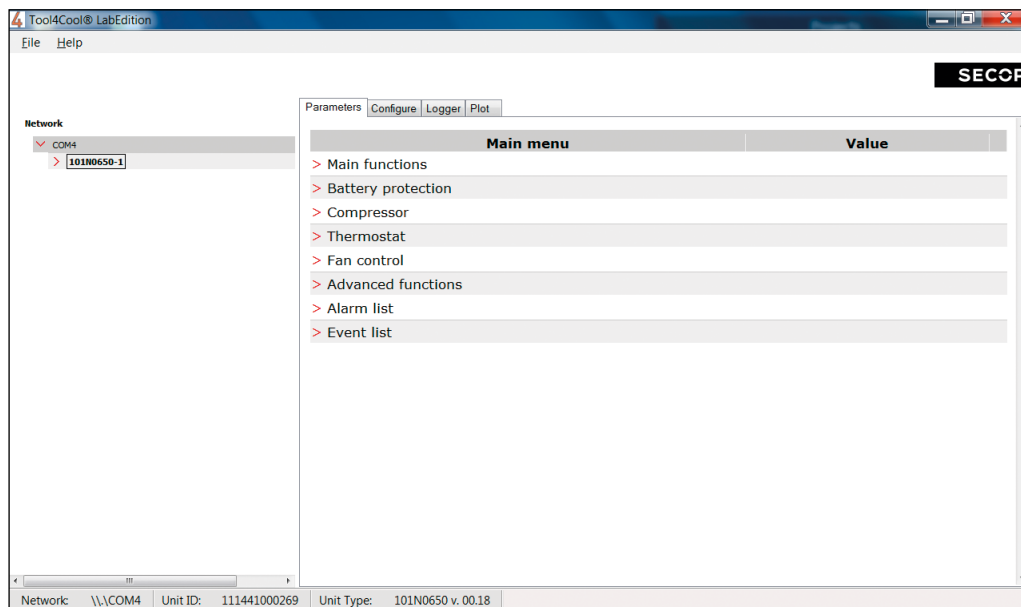

NOTES

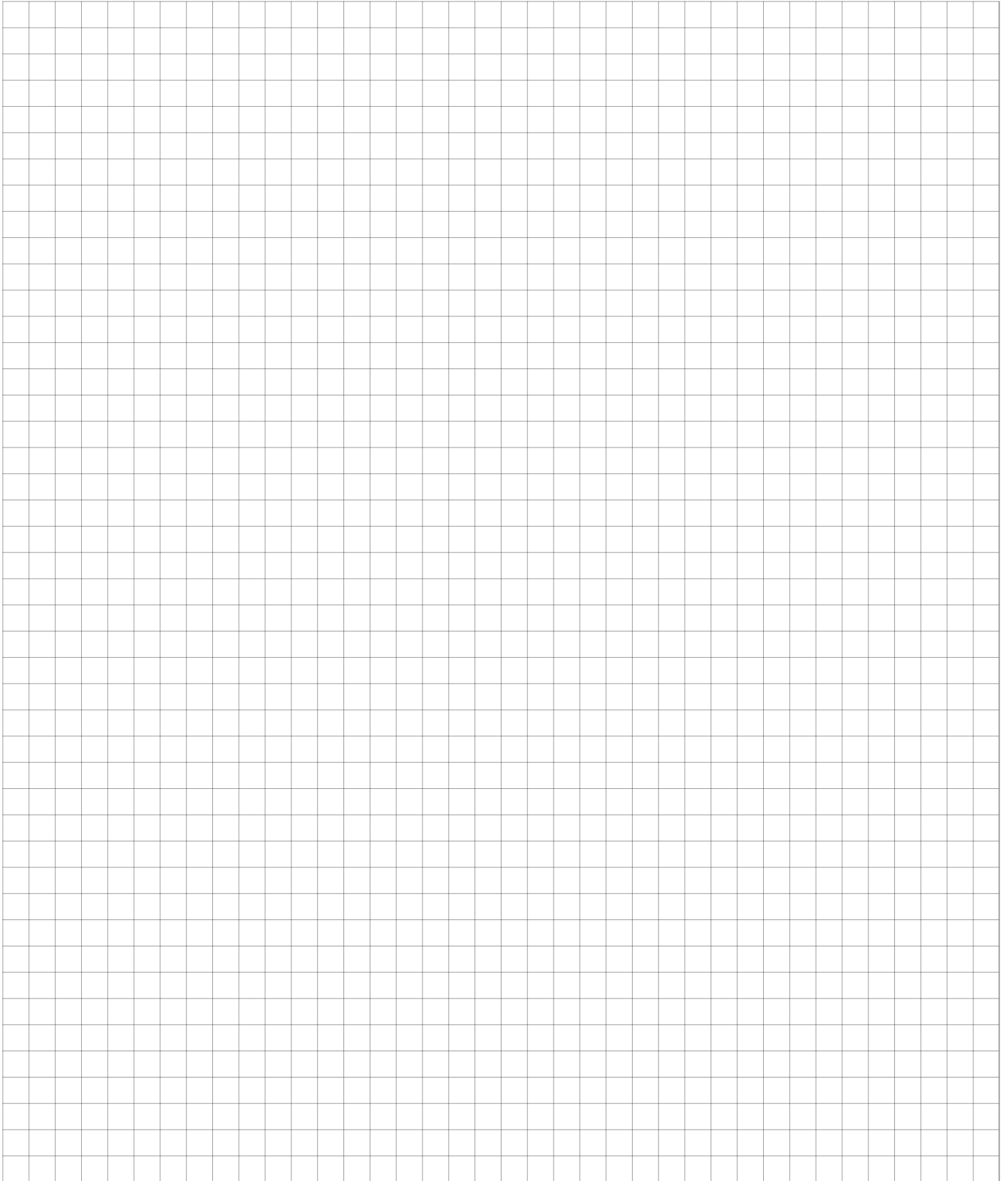

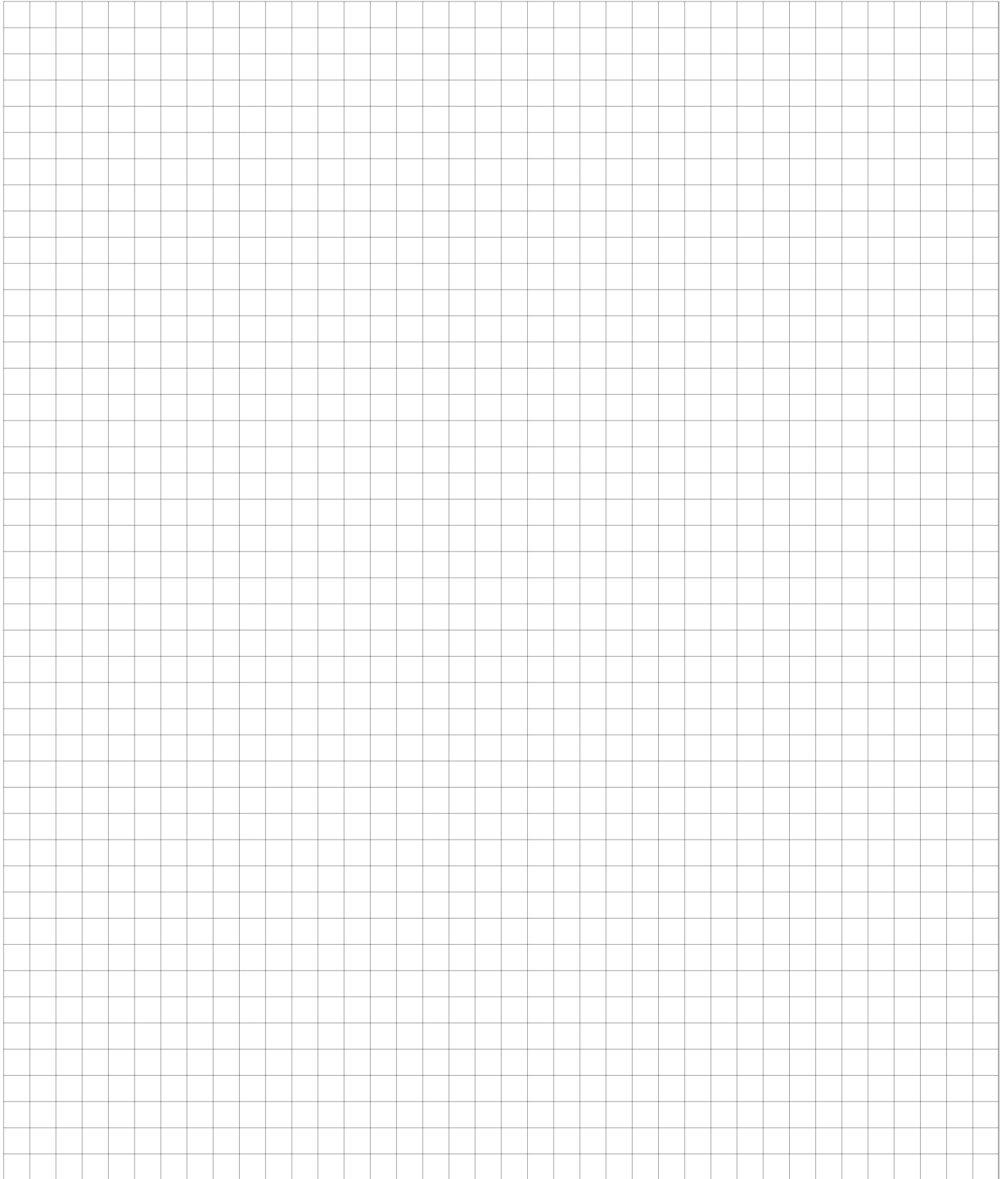

TOOL4COOL® SOFTWARE – FLEXIBLE CONTROL SETTINGS

TOOL4COOL® is a unique PC software tool that enables you to precisely configure your Secop compressors to your cooling systems.

Via microprocessor-based controllers, TOOL4COOL® gives you easy access to all parameters. These can be changed, monitored, downloaded or uploaded to get the optimum performance out of your cooling system. TOOL4COOL® covers a wide range of applications within parking cooling, light commercial cooling and transport cooling and much more. Using TOOL4COOL®, you can determine the basic specifications of your product, giving you the ability to clearly differentiate yourself in the market.



OUR JOURNEY SO FAR

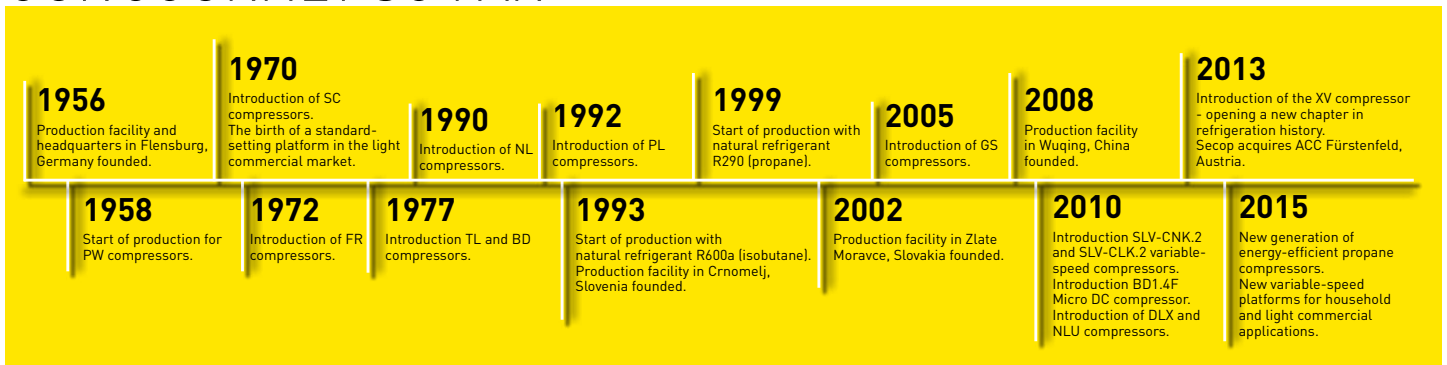

Low Cooling Capacity High

HOUSEHOLD

LIGHT COMMERCIAL

AC



DC



DC-POWERED