





■ NAVIGATION LIGHTS

## SERIES 20

USCG	IMO	RINA	MCA
GL	A-16	CE	BA 9s 12V, 5W

Dimensions in: mm/inch

### Series 20

**Navigation lights –**  
Specially designed for motor boats,  
easy to fit

#### Application

Application depending on required visibilities.  
See table in technical information.

#### Housing

Black or white polycarbonate. Seawater resistant, non-corrosive and non-magnetic, impact and shock resistant

#### Optics

Lens: Fresnel, range of visibility 2 nm (starboard, port and bicolor 1 nm).  
Material: polycarbonate, impact and shock resistant

#### Protection degree

IP 45

#### Mounting

Side-mount or deck-mount

#### Electric

Bulb included

1

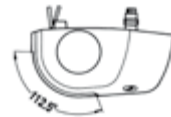
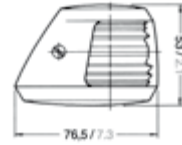

2

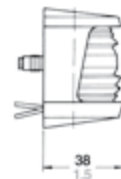
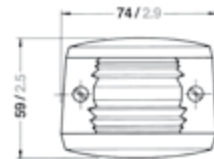

3

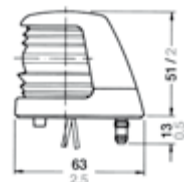





No.		Description	Ship size	Wattage	Visibility	Housing colour	Mounting	Voltage	Article number
1		Starboard	< 12 m / < 39 ft.	5 W	1 nm	Black	side-mount	12 V	3571001000
		Starboard	< 12 m / < 39 ft.	5 W	1 nm	White	side-mount	12 V	3571301000
		Port	< 12 m / < 39 ft.	5 W	1 nm	Black	side-mount	12 V	3572001000
		Port	< 12 m / < 39 ft.	5 W	1 nm	White	side-mount	12 V	3572301000
2		Stern	< 12 m / < 39 ft.	5 W	2 nm	Black	side-mount	12 V	3573001000
		Stern	< 12 m / < 39 ft.	5 W	2 nm	White	side-mount	12 V	3573301000
3		Starboard, deck-mount	< 12 m / < 39 ft.	5 W	1 nm	Black	deck-mount	12 V	3575101000
		Port, deck-mount	< 12 m / < 39 ft.	5 W	1 nm	Black	deck-mount	12 V	3575201000
		Bicolor	< 12 m / < 39 ft.	5 W	1 nm	Black	deck-mount	12 V	3575001000
		Bicolor	< 12 m / < 39 ft.	5 W	1 nm	White	deck-mount	12 V	3575301000
		Masthead	< 12 m / < 39 ft.	5 W	2 nm	Black	deck-mount	12 V	3574001000
		Masthead	< 12 m / < 39 ft.	5 W	2 nm	White	deck-mount	12 V	3574301000

SERIES 20

┌ Dimensions in: mm/inch ─┐

4

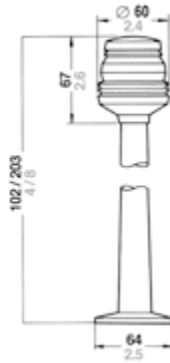

5

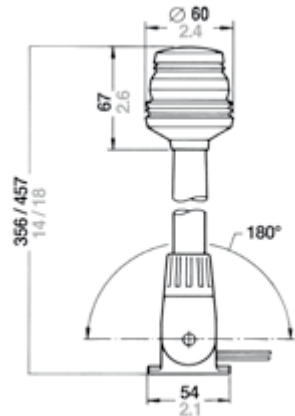



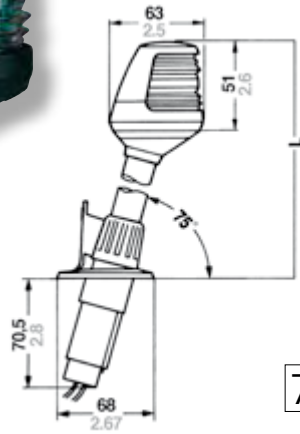

6

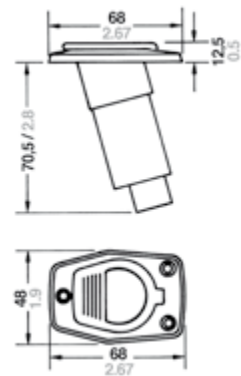

7



No.		Description	Ship size	Wattage	Visibility	Housing colour	Voltage	Article number
4		All-round white, pedestal, 102 mm / 4 inch.	12 - < 50 m / 39 - < 164 ft.	5 W	2 nm	Black	12 V	3570030000
		All-round white, pedestal, 102 mm / 4 inch.	12 - < 50 m / 39 - < 164 ft.	5 W	2 nm	White	12 V	3570330000
5		All-round white, fold down, 356 mm / 14 inch.	12 - < 50 m / 39 - < 164 ft.	5 W	2 nm	Black	12 V	3570001000
		All-round white, fold down, 356 mm / 14 inch.	12 - < 50 m / 39 - < 164 ft.	5 W	2 nm	White	12 V	3570301000
		All-round white, fold down, 457 mm / 18 inch.	12 - < 50 m / 39 - < 164 ft.	5 W	2 nm	Black	12 V	3570002000
		All-round white, fold down, 457 mm / 18 inch.	12 - < 50 m / 39 - < 164 ft.	5 W	2 nm	White	12 V	3570302000
		Masthead, fold down, 356 mm / 14 inch.	< 12 m / < 39 ft.	5 W	2 nm	Black	12 V	3574003000
6		All-round white, plug-in, 1066 mm / 42 inch.	12 - < 50 m / 39 - < 164 ft.	5 W	2 nm	Black	12 V	3570010000
		All-round white, plug-in, 1066 mm / 42 inch.	12 - < 50 m / 39 - < 164 ft.	5 W	2 nm	White	12 V	3570310000
		All-round white, plug-in, 1220 mm / 48 inch.	12 - < 50 m / 39 - < 164 ft.	5 W	2 nm	White	12 V	3570311000
7		Plug-in base				Black		8357001600
		Plug-in base				White		8357002400





Spare Parts /\*Extras  
Ersatzteile /\*Zubehör  
Pièces de rechange /\*Accessoires

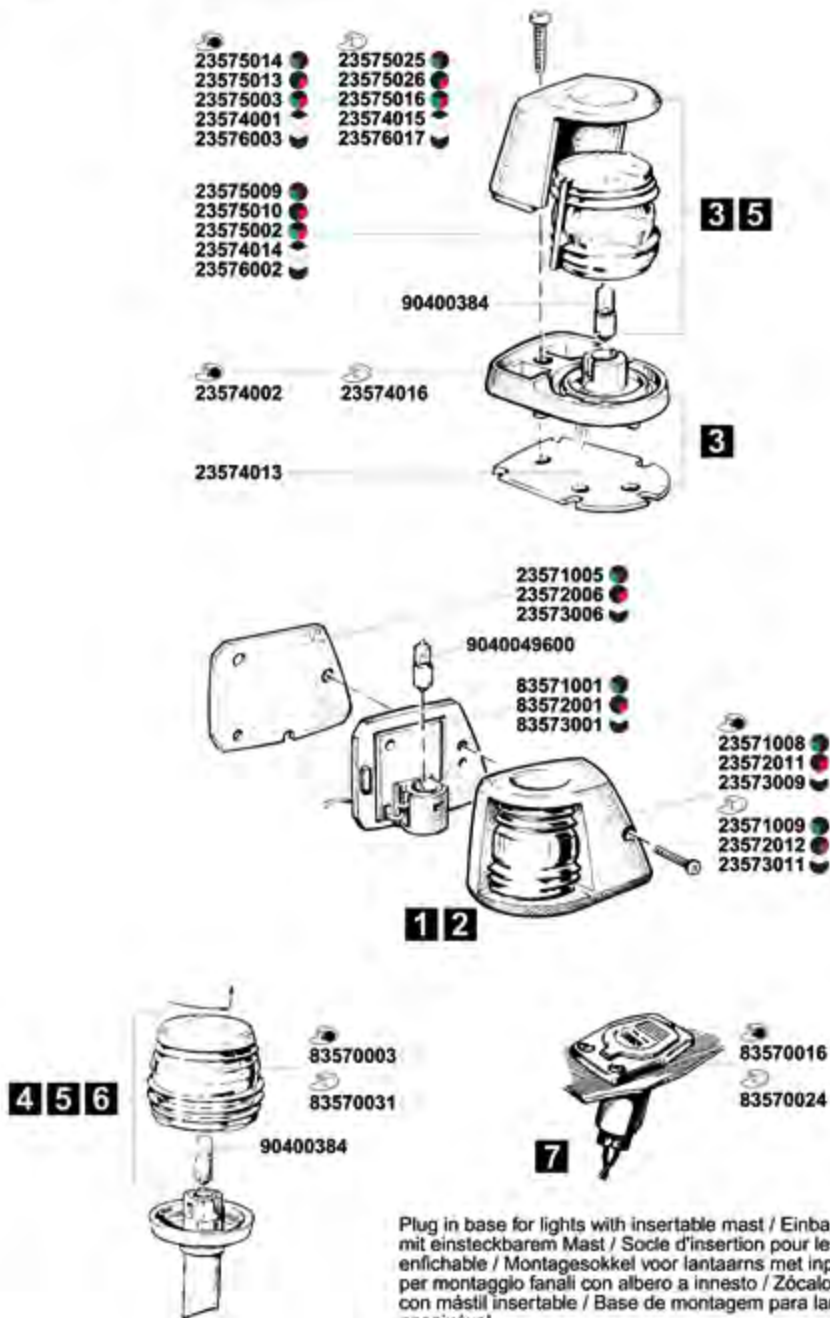





## SERIES 23



Dimensions in: mm/inch

**LED** technology

### Series 23

**LED battery navigation lights –**  
For more safety and better  
visibility of small boats  
when daylight is fading

#### Application

Boats < 7 m, max. 7 knots

#### Housing

Rubber black, watertight, buoyant

#### Optics

Plastic, seawater resistant, easy to change

#### Mounting

See drawing

#### Electric

4 AA / Mignon 1.5 V battery  
(not included), on / off switch,  
bulb included



No.		Description	Ship size	Wattage	Housing colour	Mounting	Voltage	Article number
1		Bicolor	< 7 m / < 23 ft.	1 W	Black	Mounting with suction cup	4 x 1,5 AA	3723400700
2		Bicolor	< 7 m / < 23 ft.	1 W	Black	For mounting on inflatables	4 x 1,5 AA	3723402700
3		All-round white, stern	< 7 m / < 23 ft.	1 W	Black	For mounting on inflatables	4 x 1,5 AA	3723410700
4		All-round white, stern	< 7 m / < 23 ft.	1 W	Black	Mounting with c-clamp	4 x 1,5 AA	3723440700
5		All-round white, stern	< 7 m / < 23 ft.	1 W	Black	Mounting with suction cup	4 x 1,5 AA	3723490700

#### Spare Parts / Extras

		LED insert		1 W				3790423700
--	--	------------	--	-----	--	--	--	------------

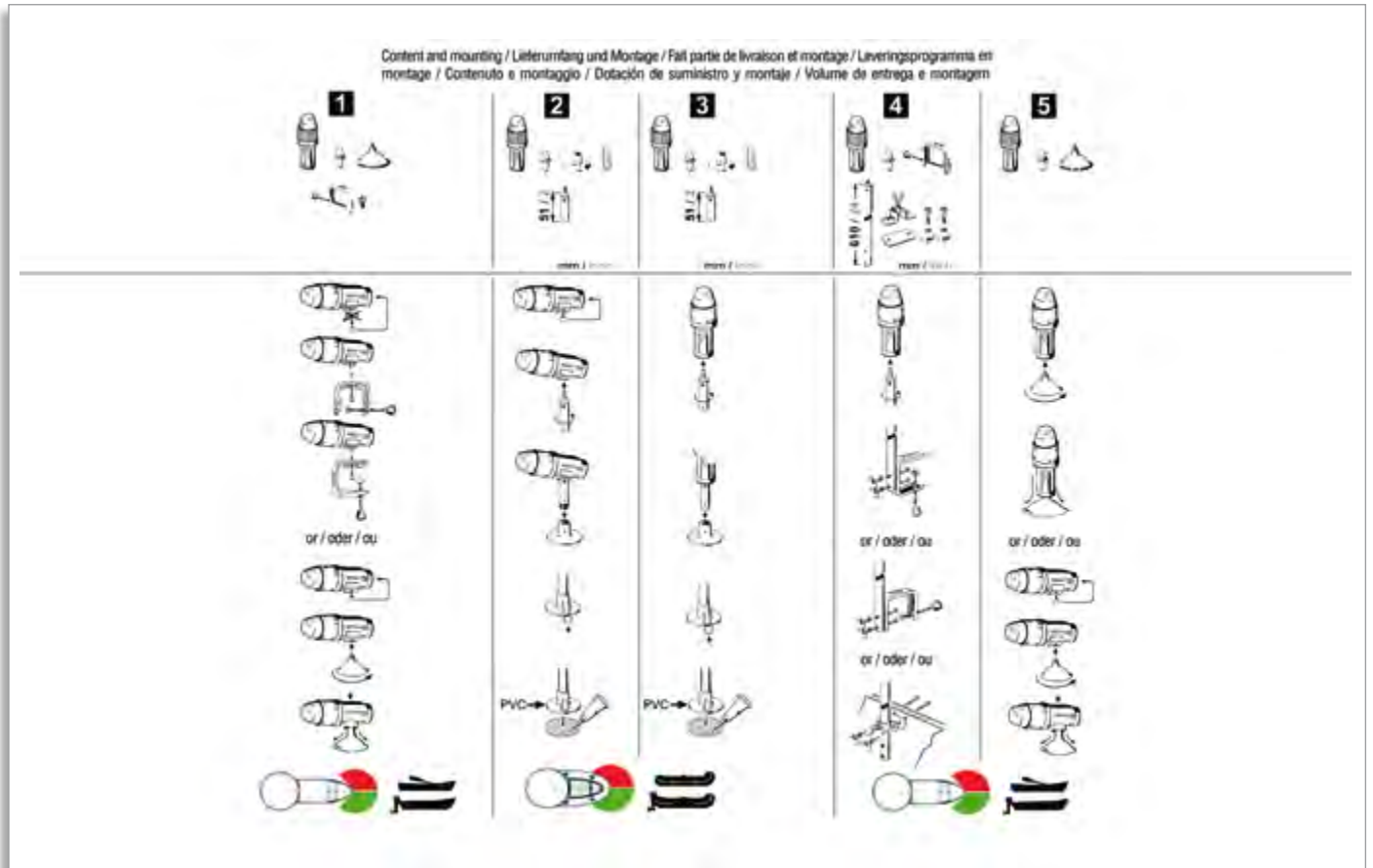

## SERIES 24



Dimensions in: mm/inch

### Series 24

#### Navigation lights – With tell-tale indicator

##### Application

Application depending on required visibilities.  
See table in technical information.

##### Housing

Stainless steel and polycarbonate, non-corrosive  
and seawater resistant

##### Optics

Plastic, seawater resistant

##### Mounting

Deck-mount, including 2 screws

##### Electric

With 2-wire cable,  
bulb included

1

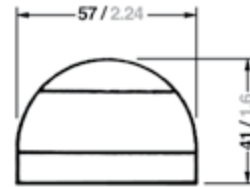

2

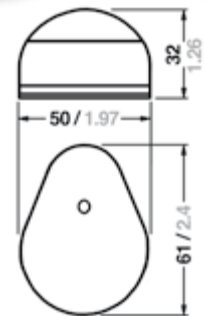

3

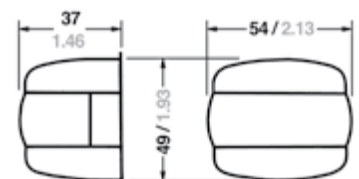







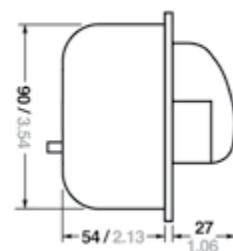
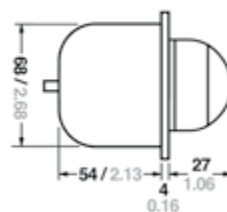
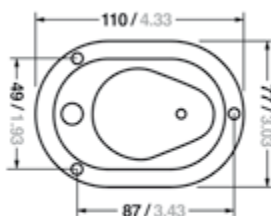











4

Incorporated switch automatically turns light off when it is fold down.



No.		Description	Ship size	Wattage	Visibility	Housing colour	Mounting	Voltage	Article number
1		Starboard, with tell-tale	< 12 m / < 39 ft.	10 W	2 nm	Stainless steel	deck-mount	12 V	3724225700
		Port, with tell-tale	< 12 m / < 39 ft.	10 W	2 nm	Stainless steel	deck-mount	12 V	3724325700
	 	Starboard / Port set	< 12 m / < 39 ft.	10 W	2 nm	Stainless steel	deck-mount	12 V	3724227700
	 	Bicolor, with tell-tale	< 12 m / < 39 ft.	10 W	2 nm	Stainless steel	deck-mount	12 V	3724125700
2		Starboard	< 12 m / < 39 ft.	10 W	2 nm	Stainless steel	deck-mount	12 V	3724205700
		Port	< 12 m / < 39 ft.	10 W	2 nm	Stainless steel	deck-mount	12 V	3724305700
	 	Starboard / Port set	< 12 m / < 39 ft.	10 W	2 nm	Stainless steel	deck-mount	12 V	3724226700
	 	Bicolor	< 12 m / < 39 ft.	10 W	2 nm	Stainless steel	deck-mount	12 V	3724105700
3		Starboard	< 12 m / < 39 ft.	10 W	2 nm	Stainless steel	side-mount	12 V	3724202700
		Port	< 12 m / < 39 ft.	10 W	2 nm	Stainless steel	side-mount	12 V	3724302700
	 	Starboard / Port set	< 12 m / < 39 ft.	10 W	2 nm	Stainless steel	side-mount	12 V	3724228700
4		Bicolor, with tell-tale, hide-away	< 12 m / < 39 ft.	10 W	2 nm	Stainless steel	deck-mount	12 V	3724600700

Spare Parts / Extras

		Festoon bulb						12 V	3790022100
--	--	--------------	--	--	--	--	--	------	------------

## SERIES 25 STANDARD

USCG	IMO	RINA	MCA
GL	A-16	CE	Special 10 W

Dimensions in: mm/inch

### Series 25 Standard

**Robust navigation lights –  
Made of plastic in black and white**

#### Application

Application depending on required visibilities.  
See table in technical information.

#### Housing

Polycarbonate, impact and shock resistant,  
non-corrosive, non-magnetic, seawater resistant

#### Optics

Lens: Fresnel, range of visibility 2 nm (starboard,  
port and bicolor 1 nm). Material: plastic, impact  
and shock-proof, seawater resistant

#### Protection degree

IP 45

#### Mounting

Side-mount or deck-mount

#### Electric

With 2-wire cable,  
bulb included

1

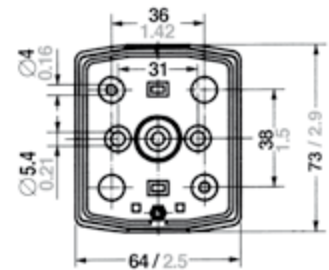
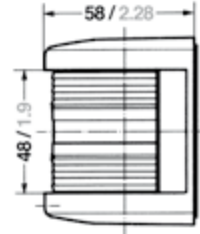

2

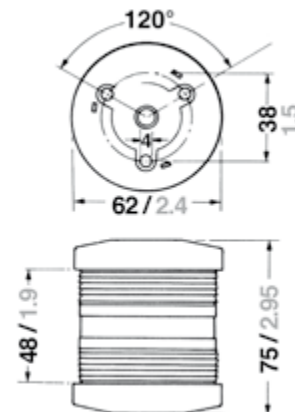

No.		Description	Ship size	Wattage	Visibility	Housing colour	Mounting	Voltage	Article number
1		Starboard	< 12 m / < 39 ft.	10 W	1 nm	Black	side-mount	12 V	3519102000
		Starboard	< 12 m / < 39 ft.	10 W	1 nm	White	side-mount	12 V	3519112000
		Port	< 12 m / < 39 ft.	10 W	1 nm	Black	side-mount	12 V	3520202000
		Port	< 12 m / < 39 ft.	10 W	1 nm	White	side-mount	12 V	3520212000
		Bicolor	< 12 m / < 39 ft.	10 W	1 nm	Black	side-mount	12 V	3518302000
		Bicolor	< 12 m / < 39 ft.	10 W	1 nm	White	side-mount	12 V	3518312000
		Masthead	< 12 m / < 39 ft.	10 W	2 nm	Black	side-mount	12 V	3516002000
		Masthead	< 12 m / < 39 ft.	10 W	2 nm	White	side-mount	12 V	3516012000
		Stern	< 50 m / < 164 ft.	10 W	2 nm	Black	side-mount	12 V	3517702000
		Stern	< 50 m / < 164 ft.	10 W	2 nm	White	side-mount	12 V	3517712000
2		All-round white	< 50 m / < 164 ft.	10 W	2 nm	Black	deck-mount	12 V	3513012000
		All-round white	< 50 m / < 164 ft.	10 W	2 nm	White	deck-mount	12 V	3513096000
		All-round red	< 50 m / < 164 ft.	21 W	2 nm	Black	deck-mount	12 V	3513222000
		All-round green	< 50 m / < 164 ft.	21 W	2 nm	Black	deck-mount	12 V	3513122000

Spare Parts /\*Extras  
Ersatzteile /\*Zubehör  
Pièces de rechange /\*Accessoires

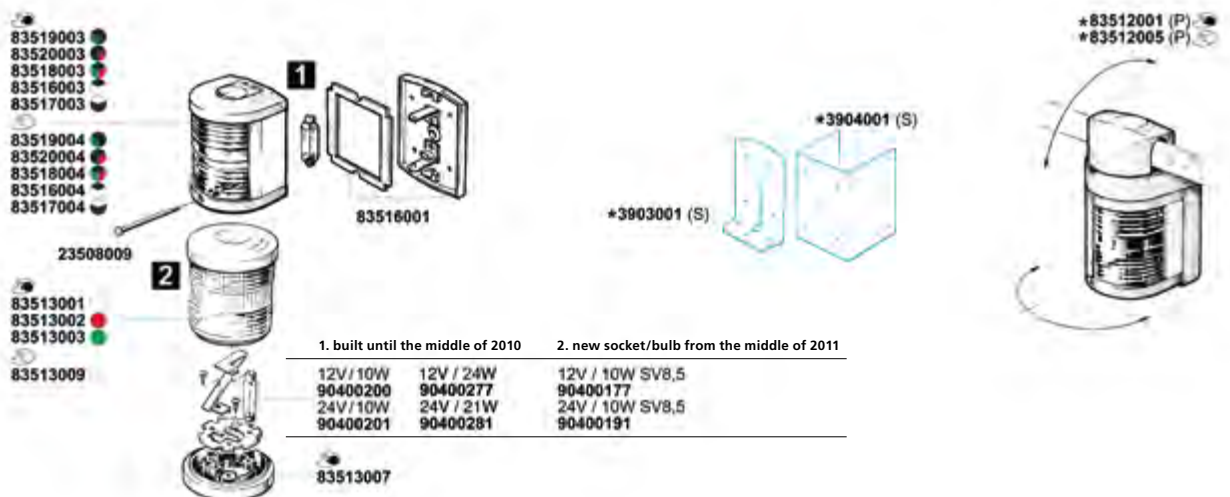



## SERIES 25 CLASSIC



Dimensions in: mm/inch

### Series 25 Classic

**Navigation lights –  
Classic look with stainless steel components**

#### Application

Application depending on required visibilities.  
See table in technical information.

#### Housing

Polycarbonate black or white, impact and shock resistant, non-corrosive, non-magnetic, seawater resistant

#### Optics

Lens: Fresnel, range of visibility 2 nm (starboard, port and bicolor 1 nm). Material: plastic, impact resistant and shock-proof, seawater resistant

#### Protection degree

IP 45

#### Mounting

Side-mount

#### Electric

With 2-wire cable,  
bulb included

1

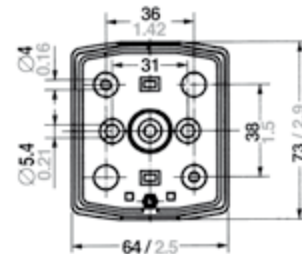
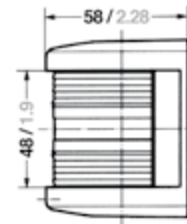

2

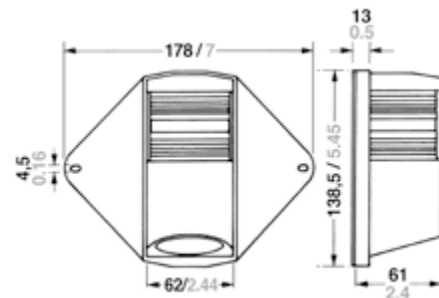

No.		Description	Ship size	Wattage	Visibility	Housing colour	Mounting	Voltage	Article number
1		Starboard	< 12 m / < 39 ft.	10 W	1 nm	Black	side-mount	12 V	3511102000
		Starboard	< 12 m / < 39 ft.	10 W	1 nm	White	side-mount	12 V	3511195000
		Port	< 12 m / < 39 ft.	10 W	1 nm	Black	side-mount	12 V	3510202000
		Port	< 12 m / < 39 ft.	10 W	1 nm	White	side-mount	12 V	3510295000
		Bicolor	< 12 m / < 39 ft.	10 W	1 nm	Black	side-mount	12 V	3512302000
		Bicolor	< 12 m / < 39 ft.	10 W	1 nm	White	side-mount	12 V	3512395000
		Masthead	< 12 m / < 39 ft.	10 W	2 nm	Black	side-mount	12 V	3508002000
		Masthead	< 12 m / < 39 ft.	10 W	2 nm	White	side-mount	12 V	3508095000
		Stern	< 50 m / < 164 ft.	10 W	2 nm	Black	side-mount	12 V	3509002000
		Stern	< 50 m / < 164 ft.	10 W	2 nm	White	side-mount	12 V	3509095000
2		Masthead / foredeck combination	< 12 m / < 39 ft.	10 W (Masthead), 20 W (Foredeck)	2 nm	Black	mast only, side-mount	12 V	3106012000

Spare Parts /\* Extras  
Ersatzteile /\* Zubehör  
Pièces de rechange /\* Accessoires

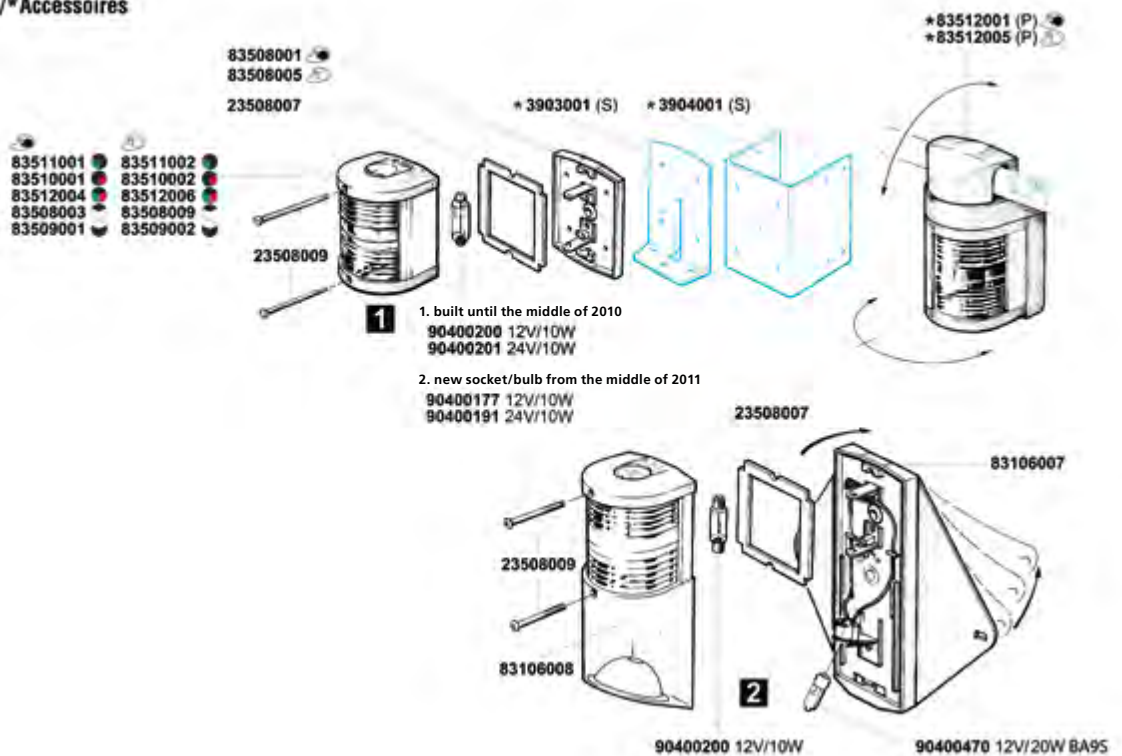

## SERIES 30

USCG

IMO

A-16

CE

Dimensions in: mm/inch

**LED**  
technology

### Series 30

**LED navigation lights –  
Specially designed for motor boats,  
easy to fit**

#### Application

Application depending on required visibilities.  
See table in technical information.

#### Housing

Black polycarbonate. Seawater resistant,  
non-corrosive and non-magnetic, impact  
and shock resistant

#### Optics

Polycarbonate with a prismatic lens

#### Protection degree

IP 67

#### Mounting

Deck-mount, pre-wired with 160 mm cable  
2 x 0.30 mm<sup>2</sup> / AWG 18

#### Electric

With 2-wire cable,  
bulb included



No.		Description	Ship size	Wattage	Visibility	Housing colour	Mounting	Voltage	Article number
1	360°	All-round white, pedestal length mounting arm 10 cm	< 20 m / < 65 ft.	1 W	2 nm	Black	deck- mount	12 V	3820011000
2	360°	All-round white, fold down length mounting arm 30 cm	< 20 m / < 65 ft.	1 W	2 nm	Black	deck- mount	12 V	3820003000
3	360°	All-round white, plug-in length mounting arm 135 cm	< 20 m / < 65 ft.	1 W	2 nm	Black	deck- mount	12 V	3820031000





## SERIES 32

USCG	IMO	RINA	MCA
BSH	GL	A-16	CE

Dimensions in: mm/inch

**LED**  
micrologie

### Series 32

**LED navigation lights –**  
Extremely long service life without loss of output due to innovative temperature management. High durability through the moulding of wiring and LED in one casing

#### Application

Application depending on required visibilities. See table in technical information.

#### Housing

Polycarbonate, seawater resistant, UV protected, non-corrosive, non-magnetic, impact and shock resistant

#### Optics

Innovative lens technology for wide visibility requires only one light-emitting diode

#### Mounting

Deck-mount

#### Electric

Invers polarity protection included, bulb included



1

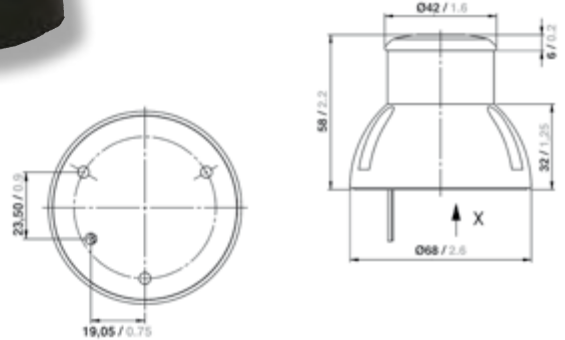
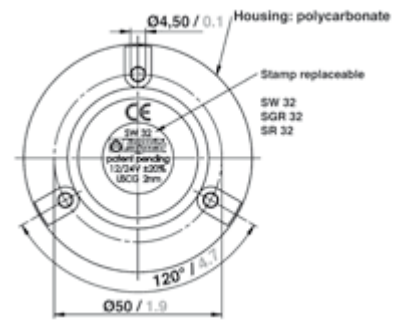

2

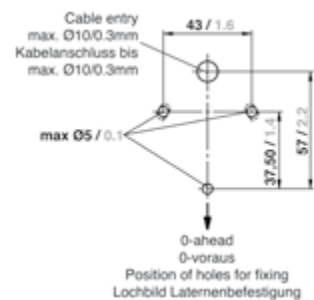
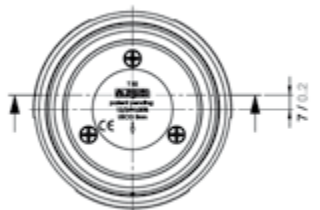
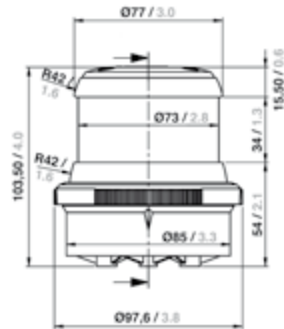



No.		Description	Ship size	Wattage	Visibility	Housing colour	Mounting	Voltage	Article number
1		All-round white	< 50 m / < 164 ft.	1,5 W	2 nm	Black	deck-mount	12 V, 24 V	3804001000
		All-round white	< 50 m / < 164 ft.	1,5 W	2 nm	White	deck-mount	12 V, 24 V	3804101000
		All-round red	< 50 m / < 164 ft.	1,5 W	2 nm	Black	deck-mount	12 V, 24 V	3804221000
		All-round red	< 50 m / < 164 ft.	1,5 W	2 nm	White	deck-mount	12 V, 24 V	3804231000
		All-round green	< 50 m / < 164 ft.	1,5 W	2 nm	Black	deck-mount	12 V, 24 V	3804121000
		All-round green	< 50 m / < 164 ft.	1,5 W	2 nm	White	deck-mount	12 V, 24 V	3804131000
2		Masthead	< 20 m / < 65 ft.	4,5 W	3 nm	Black	deck-mount	12 V, 24 V	3805051000
		Masthead	< 20 m / < 65 ft.	4,5 W	3 nm	White	deck-mount	12 V, 24 V	3805151000
		Tricolor	< 20 m / < 65 ft.	4,5 W	2 nm	Black	deck-mount	12 V, 24 V	3806051000
		Tricolor	< 20 m / < 65 ft.	4,5 W	2 nm	White	deck-mount	12 V, 24 V	3806151000





# SERIES 32

Dimensions in: mm/inch

3

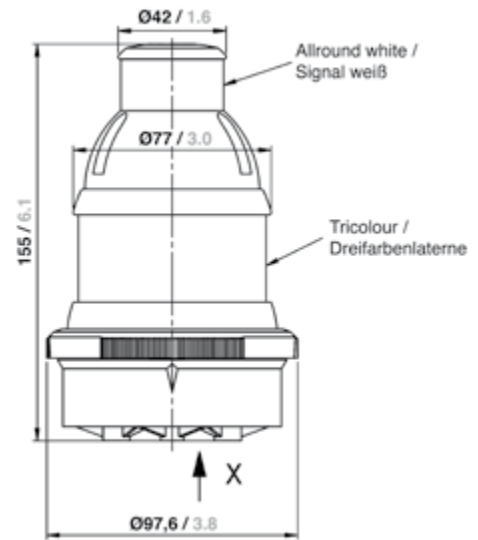
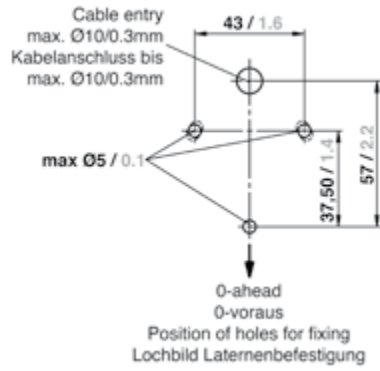

No.	Description	Ship size	Wattage	Visibility	Housing colour	Mounting	Voltage	Article number
3	Masthead / Anchor	< 20 m / < 65 ft.	4 W (Masthead), 1,5 W (Anchor)	3 nm, 2 nm	Black	deck-mount	12 V, 24 V	3807051000
	Masthead / Anchor	< 20 m / < 65 ft.	4 W (Masthead), 1,5 W (Anchor)	3 nm, 2 nm	White	deck-mount	12 V, 24 V	3807151000
	Tricolor / Anchor	< 20 m / < 65 ft.	4 W (Tricolor), 1,5 W (Anchor)	2 nm	Black	deck-mount	12 V, 24 V	3808051000
	Tricolor / Anchor	< 20 m / < 65 ft.	4 W (Tricolor), 1,5 W (Anchor)	2 nm	White	deck-mount	12 V, 24 V	3808151000



## SERIES 34



Dimensions in: mm/inch

**LED**  
micrologie

### Series 34

**LED navigation lights –**  
The latest LED generation in an  
attractive and slim design.  
Totally maintenance-free

#### Application

Application depending on required visibilities.  
See table in technical information.

#### Housing

Polycarbonate, seawater resistant, UV protected, non-corrosive, non-magnetic, impact and shock resistant

#### Optics

Innovative lens technology for wide visibility requires only one light-emitting diode

#### Mounting

Side-mount, pre-wired with 200 mm cable  
2 x 0.30 mm<sup>2</sup> / AWG 22,  
2-hole mounting

#### Electric

Invers polarity protection included,  
bulb included

1

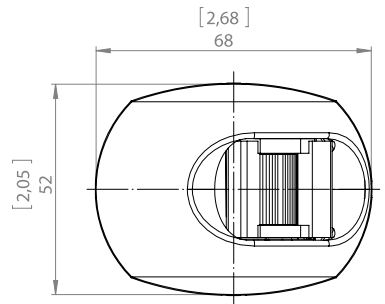

2



Stainless steel covers

3

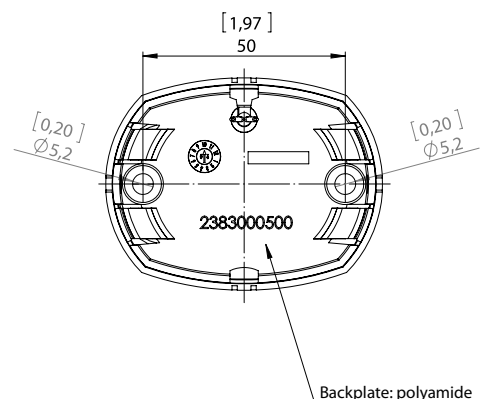

4

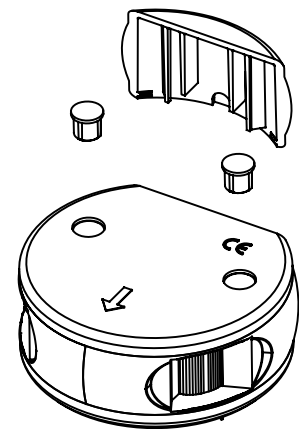
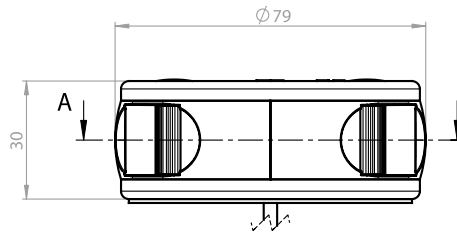

Deck-mount or under step!

No.		Description	Ship size	Wattage	Visibility	Housing colour	Mounting	Voltage	Article number
1		Starboard	< 50 m / < 164 ft.	1,5 W	2 nm	Black	side-mount	12 V, 24 V	3850001000
		Starboard	< 50 m / < 164 ft.	1,5 W	2 nm	White	side-mount	12 V, 24 V	3850101000
2		Port	< 50 m / < 164 ft.	1,5 W	2 nm	Black	side-mount	12 V, 24 V	3851001000
		Port	< 50 m / < 164 ft.	1,5 W	2 nm	White	side-mount	12 V, 24 V	3851101000
3		Stern	< 50 m / < 164 ft.	1,5 W	2 nm	Black	side-mount	12 V, 24 V	3852001000
		Stern	< 50 m / < 164 ft.	1,5 W	2 nm	White	side-mount	12 V, 24 V	3852101000
4		Bicolor	< 20 m / < 65 ft.	3 W	2 nm	Black	deck-mount	12 V, 24 V	3863001000
		Bicolor	< 20 m / < 65 ft.	3 W	2 nm	White	deck-mount	12 V, 24 V	3863101000

Spare Parts / Extras									
		Stainless steel cover, Starboard				Polished			8385000300
		Stainless steel cover, Port				Polished			8385100200
		Stainless steel cover, Stern				Polished			8385200200



## SERIES 34







### Series 34

#### Housing covers

Specially designed for the LED light series 34. Housing covers are simply fitted onto the light base. An extensive selection of designs and patterns (carbon optic, racing optic etc.) is available.

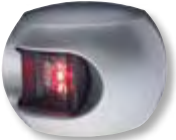
**Customer-specific designs on request.**



No.	Image	Colour / Optic	Starboard	Port	Stern
1		Black / Carbon optic	8385000301	8385100201	8385200201
		Anthracite / Carbon optic	8385000302	8385100202	8385200202
		Silver / Carbon optic	8385000303	8385100203	8385200203
		White / Carbon optic	8385000304	8385100204	8385200204
2		Black-silver / Small squares	8385000305	8385100205	8385200205
		White-silver / Small squares	8385000306	8385100206	8385200206
		Pink / Small squares	8385000307	8385100207	8385200207

No.	Image	Colour / Optic	Starboard	Port	Stern
3		Anthracite / Tiny squares	8385000308	8385100208	8385200208
		Silver / Tiny squares	8385000309	8385100209	8385200209
4		Black-silver / Dashed	8385000310	8385100210	8385200210
		Black-white / Finely dashed	8385000311	8385100211	8385200211
5		Black / Air bubbles	8385000312	8385100212	8385200212
		Silver / Air bubbles	8385000313	8385100213	8385200213
		White / Air bubbles	8385000314	8385100214	8385200214
6		Black / Water drops	8385000315	8385100215	8385200215
		White / Water drops	8385000316	8385100216	8385200216
		Blue / Water drops	8385000317	8385100217	8385200217

SERIES 34

No.	Image	Colour / Optic	Starboard	Port	Stern
7		Dark silver / Racing optic	8385000318	8385100218	8385200218
		Bright silver / Racing optic	8385000319	8385100219	8385200219
8		Black / Dots	8385000320	8385100220	8385200220
		Blue / Dots	8385000321	8385100221	8385200221
9		Black / Leopard pattern	8385000322	8385100222	8385200222
		White / Leopard pattern	8385000323	8385100223	8385200223
10		Black-purple / Marbled	8385000324	8385100224	8385200224
		Blue-purple / Marbled	8385000325	8385100225	8385200225

No.	Image	Colour / Optic	Starboard	Port	Stern
11		Dark pink / Ornaments	8385000326	8385100226	8385200226
		Bright pink / Ornaments	8385000327	8385100227	8385200227
12		Brown / Leather optic	8385000328	8385100228	8385200228





## SERIES 40



Dimensions in: mm/inch

### Series 40

#### Navigation lights – In a traditional and robust housing

##### Application

Application depending on required visibilities.  
See table in technical information.  
With -symbol on European inland waterways applicable.

##### Housing

Polycarbonate, black or white, impact and shock resistant, non-corrosive (stainless steel), non-magnetic, seawater resistant

##### Optics

Lens: Fresnel, range of visibility 2 nm (Masthead 3 nm). Material: plastic, impact resistant and shock-proof, seawater resistant

##### Protection degree

IP 56

##### Mounting

See drawing p. 35

##### Electric

With 2-wire cable, cable entry PG 9, bulb included

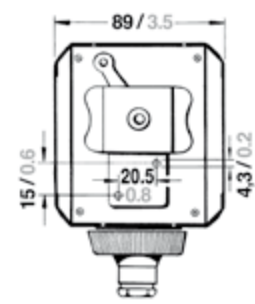
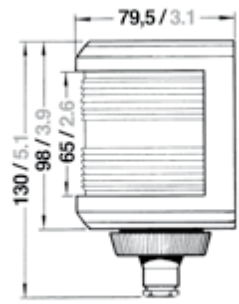

No.	Description	Ship size	Wattage	Visibility	Housing colour	Mounting	Article number 12 V	Article number 24 V
1	Starboard	< 50 m / < 164 ft.	25 W	2 nm	Black	side-mount	3505102000	3505103000
	Port	< 50 m / < 164 ft.	25 W	2 nm	Black	side-mount	3504202000	3504203000
	Bicolor	< 20 m / < 65 ft.	25 W	2 nm	Black	side-mount	3503302000	3503303000
	Masthead	< 20 m / < 65 ft.	25 W	3 nm	Black	side-mount	3501002000	3501003000
	Stern	< 50 m / < 164 ft.	10 W	2 nm	Black	side-mount	3502002000	3502003000
	Stern yellow	< 50 m / < 164 ft.	10 W	2 nm	Black	side-mount	3502402000	3502403000

2

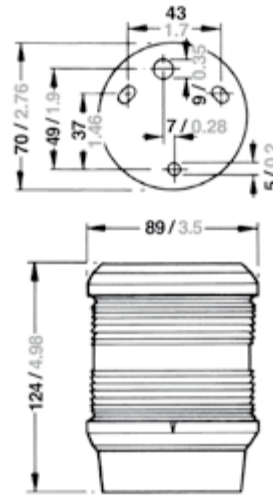

3

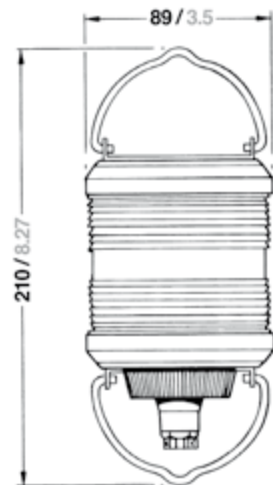

No.		Description	Ship size	Wattage	Visibility	Housing colour	Mounting	Article number 12 V	Article number 24 V
2		All-round white (deck-mount)	< 50 m / < 164 ft.	10 W	2 nm	Black	deck-mount	3506032000	3506033000
		All-round white (deck-mount)	< 50 m / < 164 ft.	10 W	2 nm	White	deck-mount	3506629000	3506639000
		All-round red (deck-mount)	< 50 m / < 164 ft.	25 W	2 nm	Black	deck-mount	3506232000	3506233000
		All-round green (deck-mount)	< 50 m / < 164 ft.	25 W	2 nm	Black	deck-mount	3506132000	3506133000
3		All-round white (hoistable)	< 50 m / < 164 ft.	10 W	2 nm	Black	hoistable	3506002000	3506003000
		All-round red (hoistable)	< 50 m / < 164 ft.	25 W	2 nm	Black	hoistable	3506202000	3506203000
		All-round green (hoistable)	< 50 m / < 164 ft.	25 W	2 nm	Black	hoistable	3506102000	3506103000

SERIES 40

4



5

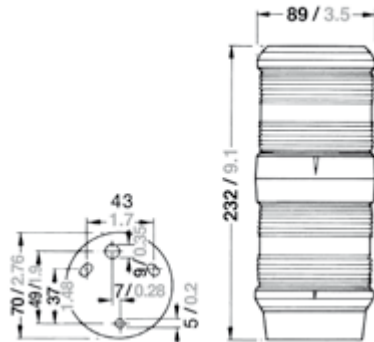
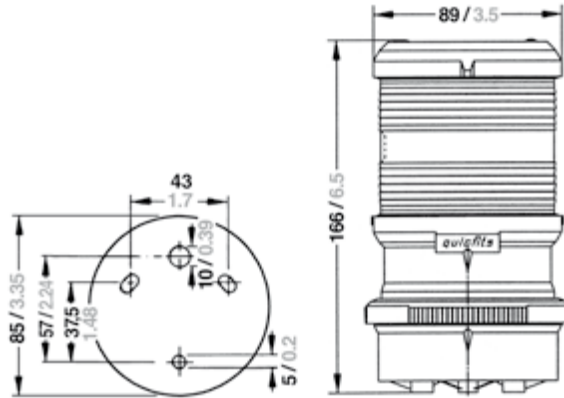

No.		Description	Ship size	Wattage	Visibility	Housing colour	Mounting	Article number 12 V	Article number 24 V
4		All-round white, Quicfits	< 50 m / < 164 ft.	10 W	2 nm	Black	deck-mount	3506652000	3506653000
5	 	Masthead / Anchor combination	< 20 m / < 65 ft.	25 W (Masthead), 10 W (Anchor)	3 nm (Masthead), 2 nm (Anchor)	White	deck-mount	3514502000	3514503000

Bracket variants for Series 40

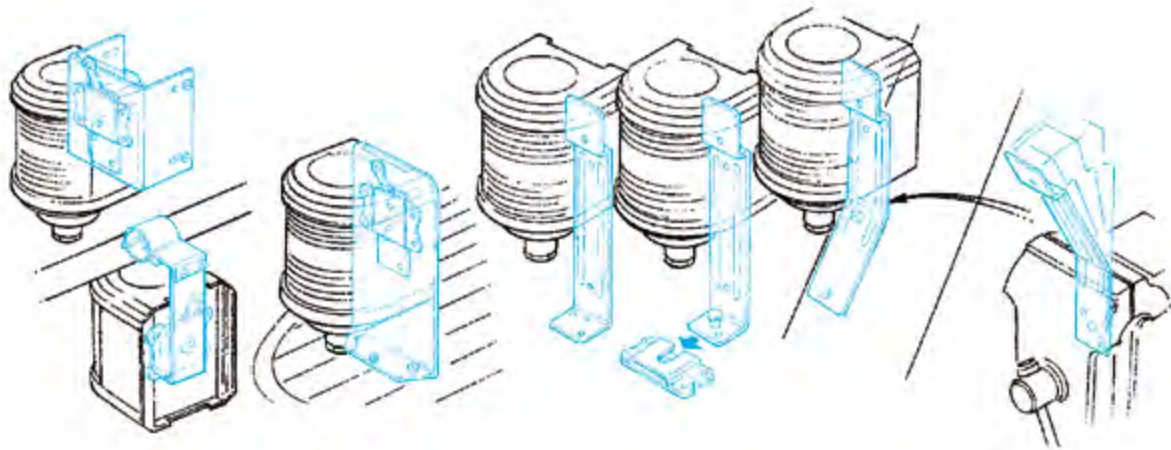

**Spare Parts /\*Extras**  
**Ersatzteile /\*Zubehör**  
**Pièces de rechange /\*Accessoires**

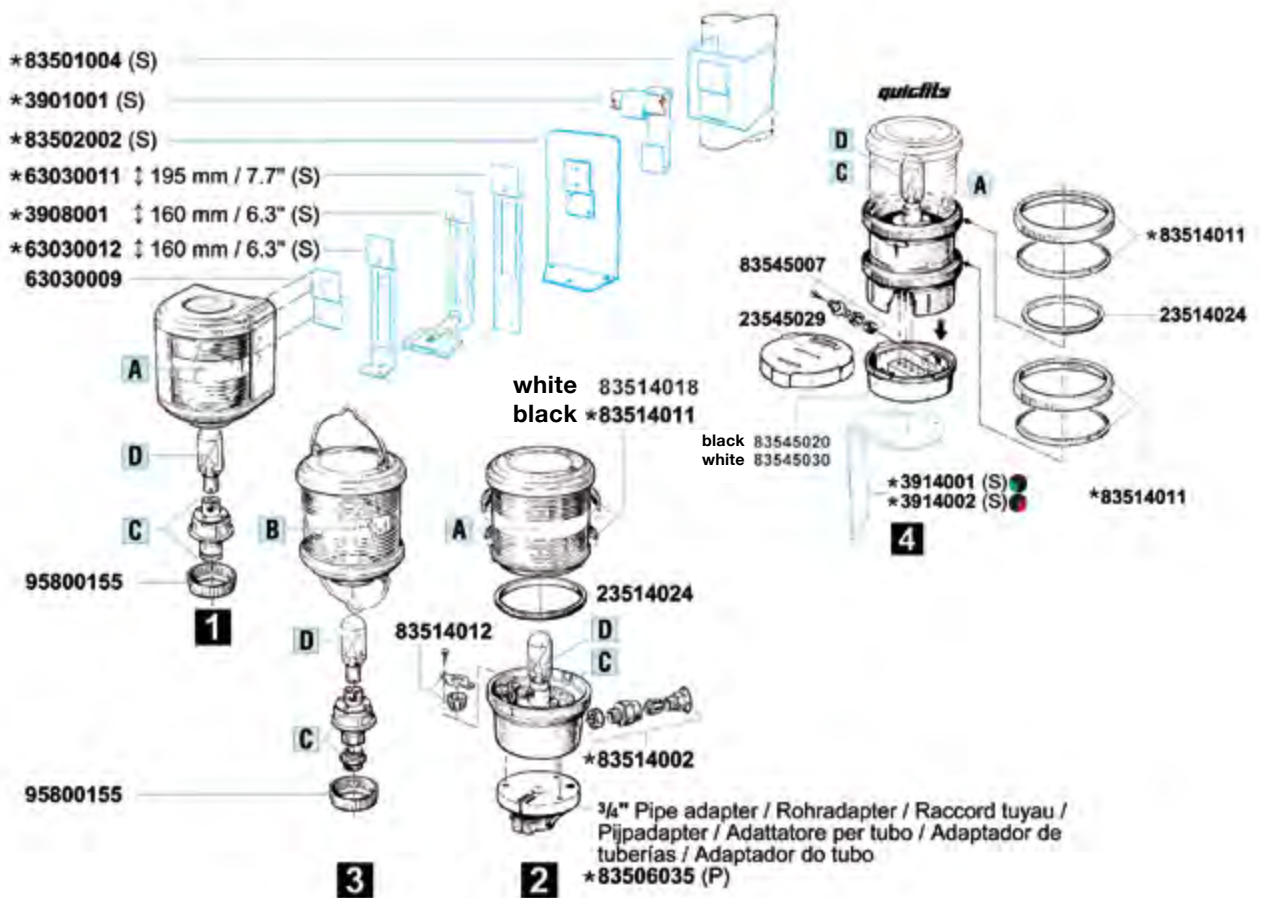

	A	B	C	D
<b>1</b>	83505002	-	83501006	12V/25W 90400002
	83504002	-		
	83503001	-		
	83501008	-		
	83502003	-		
	83502004	-		12V/10W 90400005
<b>2-4</b>	83507008	-	<b>2</b> 90200127	24V/25W 90400003
	83506022	83506005	<b>3</b> 83506001	24V/10W 90400006
	83506030	-	<b>4</b> 90200127	
	83506023	83506007		
	83506024	83506009		
<b>5</b>	83514020	-	90200127	

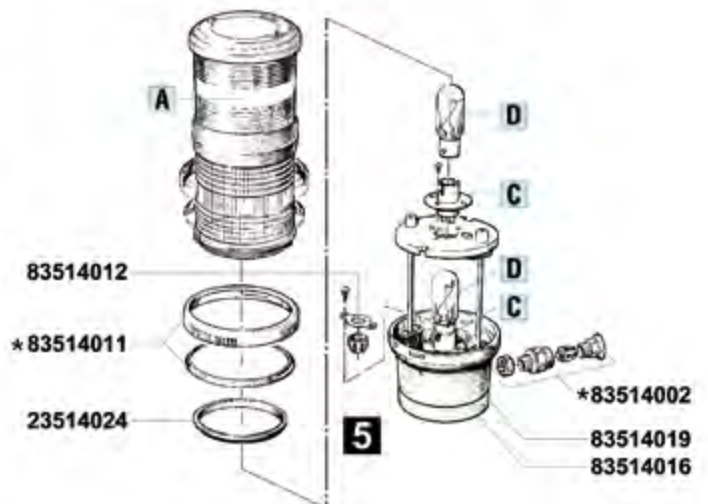



## SERIES 40



Dimensions in: mm/inch

### SERIES 40

Sailboat lights and strobe lights –  
Also with aqua signal *quickfits* system for  
easy dismounting for the transport and  
winter storage

#### Application

Application depending on required visibilities.  
See table in technical information.

#### Housing

Black polycarbonate, impact and shock  
resistant, non-corrosive, non-magnetic,  
seawater resistant

#### Optics

Lens: Fresnel, range of visibility 2 nm (strobe  
light 3 nm). Material: plastic, impact resistant  
and shock-proof, seawater resistant,  
replaceable

#### Protection degree

IP 56

#### Mounting

See drawing p. 39

#### Electric

With 2-wire cable, cable entry PG 9,  
bulb included

1

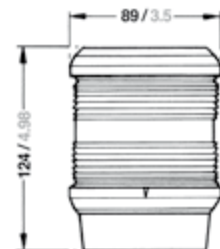
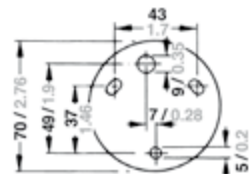

2

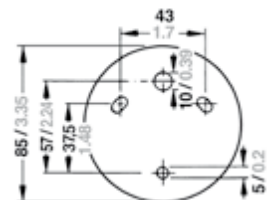

3

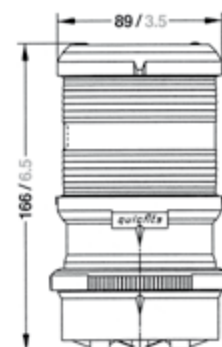





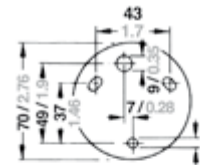
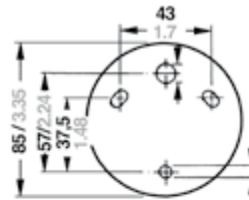

4



5



No.		Description	Ship size	Wattage	Visibility	Housing colour	Mounting	Article number 12 V	Article number 24 V
1		Tricolor	< 20 m / < 65 ft.	25 W	2 nm	Black	deck-mount	3507632000	3507633000
2		Tricolor, quicfits	< 20 m / < 65 ft.	25 W	2 nm	Black	deck-mount	3507652000	3507653000
3		Strobe, quicfits		8 W/s	3 nm	Black	deck-mount	3545052000	3545053000
		Anchor / Strobe, quicfits	< 50 m / < 164 ft.	10 W (Anchor), 8 Ws (Strobe)	2 nm, 3 nm (Strobe)	Black	deck-mount	3546052000	3546053000
4		Tricolor / Anchor, quicfits	< 20 m / < 65 ft.	25 W (Tricolor), 10 W (Anchor)	2 nm	Black	deck-mount	3514952000	3514953000
		Tricolor / Anchor / Strobe, quicfits	< 20 m / < 65 ft.	25 W (Tricolor), 10 W (Anchor), 8 Ws (Strobe)	2 nm, 3 nm (Strobe)	Black	deck-mount	3547952000	3547953000
5		Tricolor / Anchor	< 20 m / < 65 ft.	25 W (Tricolor), 10 W (Anchor)	2 nm	Black	deck-mount	3514912000	3514913000





Spare Parts /\*Extras  
Ersatzteile /\*Zubehör  
Pièces de rechange /\*Accessoires

	12 V	24 V
<b>A</b>	25 W 90400002	90400003
	10 W 90400005	90400006
<b>B</b>	90200127	
<b>C</b>	⚡ Electronic 23545009	
<b>D</b>	⚡ Electronic 83546005 83546005	

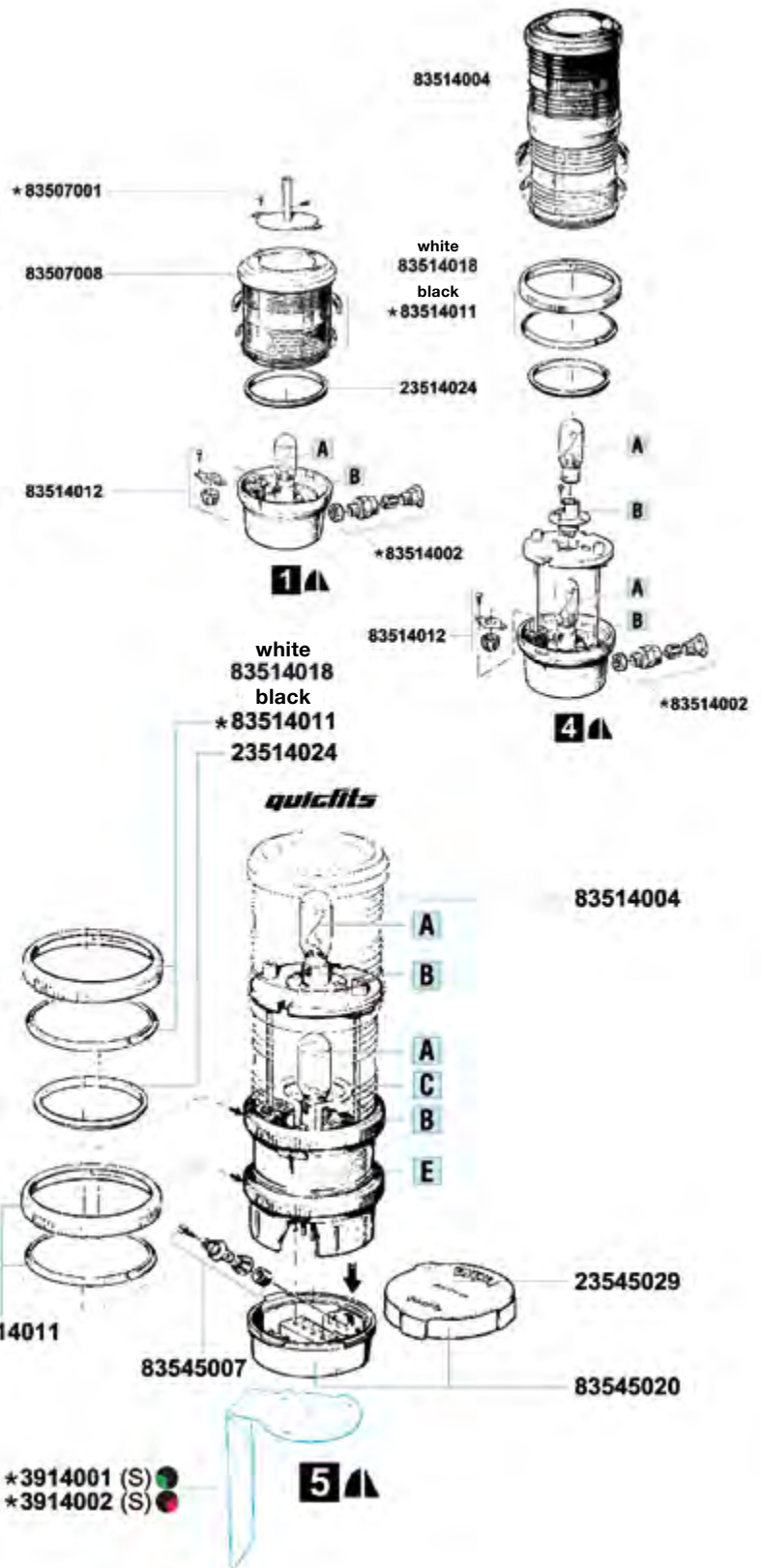

## SERIES 41



1



Dimensions in: mm/inch

### Series 41

#### Navigation lights – For direct mounting

##### Application

Application depending on required visibilities. See table in technical information. Lights with -symbol on European inland waterways applicable.

##### Housing

Polycarbonate, black or white, impact and shock resistant, non-corrosive, non-magnetic, seawater resistant

##### Optics

Lens: Fresnel, range of visibility 2 nm (masthead 3 nm). Material: plastic, impact resistant and shock-proof, seawater resistant, replaceable

##### Protection degree

IP 56

##### Mounting

Side-mount or mast-mount

##### Electric

With 2-wire cable, bulb included

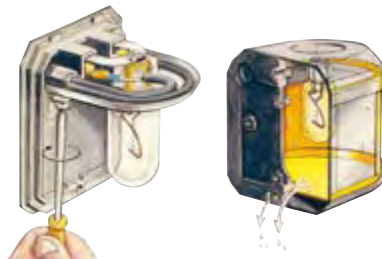
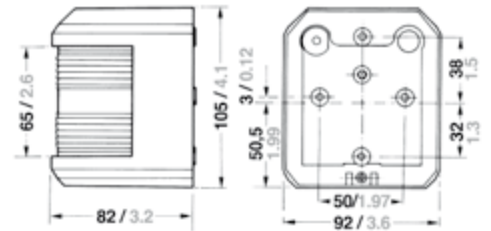

2

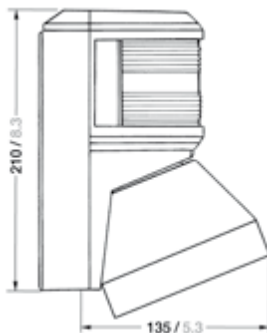

No.		Description	Ship size	Wattage	Visibility	Housing colour	Mounting	Article number 12 V	Article number 24 V
1		Starboard	< 50 m / < 164 ft.	25 W	2 nm	Black	side-mount	3543102000	3543103000
		Starboard	< 50 m / < 164 ft.	25 W	2 nm	White	side-mount	3543623000	3543626000
		Port	< 50 m / < 164 ft.	25 W	2 nm	Black	side-mount	3544202000	3544203000
		Port	< 50 m / < 164 ft.	25 W	2 nm	White	side-mount	3544623000	3544626000
		Bicolor	< 20 m / < 65 ft.	25 W	2 nm	Black	side-mount	3542302000	3542303000
		Bicolor	< 20 m / < 65 ft.	25 W	2 nm	White	side-mount	3542623000	3542626000
		Masthead	< 20 m / < 65 ft.	25 W	3 nm	Black	side-mount	3540002000	3540003000
		Masthead	< 20 m / < 65 ft.	25 W	3 nm	White	side-mount	3540623000	3540627000
		Stern	< 50 m / < 164 ft.	10 W	2 nm	Black	side-mount	3541002000	3541003000
		Stern	< 20 m / < 65 ft.	10 W	2 nm	White	side-mount	3541623000	3541626000
		Stern yellow	< 50 m / < 164 ft.	10 W	2 nm	Black	side-mount	3541402000	3541403000
	2		Masthead / Foredeck combination	< 20 m / < 65 ft.	25 W (Masthead), 35 W (Foredeck)	3 nm	Black	mast-mount	3108104000
		Masthead / Foredeck combination	< 20 m / < 65 ft.	25 W (Masthead), 35 W (Foredeck)	3 nm	White	mast-mount	3108114000	
		Masthead / Foredeck combination	< 20 m / < 65 ft.	25 W (Masthead), 50 W (Foredeck) Halogen	3 nm	Black	mast-mount	3108102000	3108103000
		Masthead / Foredeck combination	< 20 m / < 65 ft.	25 W (Masthead), 50 W (Foredeck) Halogen	3 nm	White	mast-mount	3108112000	3108113000

**Spare Parts / \*Extras**  
**Ersatzteile / \*Zubehör**  
**Pièces de rechange / \*Accessoires**

23543002  
 23544002  
 23542002  
 23540002  
 23541004  
 23543001  
 23544001  
 23540001  
 23541001  
 23543006  
 23544006  
 23540015  
 23541008  
 23540005  
 90400002 12V/25W  
 90400003 24V/25W  
 90400005 12V/10W  
 90400006 24V/10W  
 23540011  
 83540001 (cpl./kpl./cpl.)

\*3921003 (S)  
 \*3921001 (S)  
 23540006  
 \*3921002 (S)

**black**  
**23134050**  
**white**  
**23134051**

90400306 12V/35W  
 90400307 12V/50W Halogen  
 90400308 24V/50W

\*Extras / Zubehör / Accessoires / Toebehoren / Accessori / Accesorios / Acessórios  1

## SERIES 42



Dimensions in: mm/inch

### Series 42

**Semi-recessed navigation lights – In a modern design**

#### Application

Application depending on required visibilities. See table in technical information.

#### Housing

Polycarbonate, white, impact and shock resistant, non-corrosive, non-magnetic, seawater resistant

#### Optics

Lens: Fresnel, range of visibility 2 nm. Material: plastic, impact resistant and shock-proof, seawater resistant

#### Protection degree

IP 56

#### Mounting

Flush mount, see drawing

#### Electric

With 2-wire cable, bulb included

1

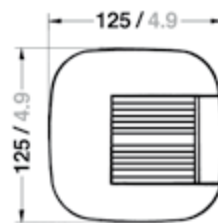

**Spare Parts / \*Extras  
Ersatzteile / \*Zubehör  
Pièces de rechange / \*Accessoires**

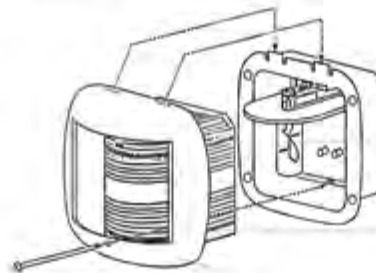

83551001

90400002 12V/25W  
90400003 24V/25W  
90400005 12V/10W  
90400006 24V/10W

83553003  
83552003  
83551003

83553002  
83552002  
83551002

No.		Description	Ship size	Wattage	Visibility	Housing colour	Mounting	Article number 12 V	Article number 24 V
1		Starboard	< 50 m / < 164 ft.	25 W	2 nm	White	side-mount semi-recessed	3553602000	3553603000
		Port	< 50 m / < 164 ft.	25 W	2 nm	White	side-mount semi-recessed	3552602000	3552603000
		Stern	< 50 m / < 164 ft.	10 W	2 nm	White	side-mount semi-recessed	3551602000	3551603000





## SERIES 43

IMO

RINA

MCA

BSH

GL

CE

Dimensions in: mm/inch

**LED**  
micrologie

### Series 43

**LED navigation lights –  
Modern design and optimised size  
for sports boats and yachts up to 50 m**

#### Application

Application depending on required visibilities.  
See table in technical information.

#### Housing

Polycarbonate

#### Optics

2 LEDs for more colour-brightness  
and double safety

#### Protection degree

IP 67

#### Mounting







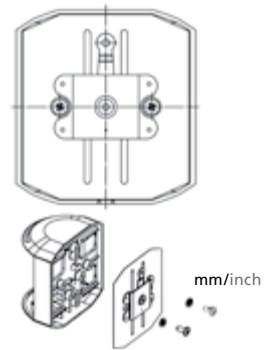
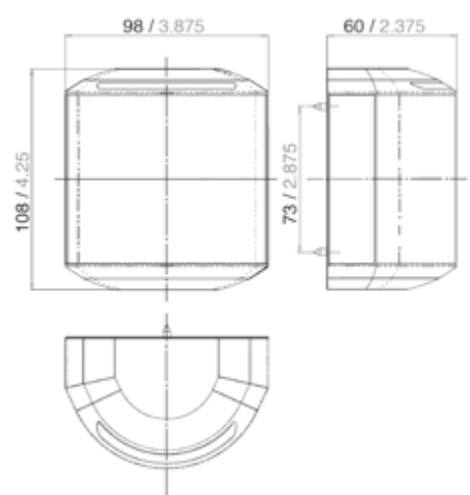
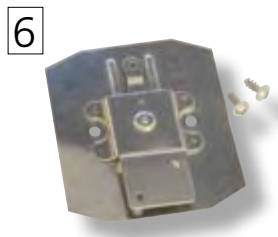



Side-mount, pre-wired, 4-hole mounting,  
identical with Series 41. Mounting plate (extra)  
available for Series 40 / 50

#### Electric

Invers polarity protection included,  
bulb included





No.		Description	Ship size	Wattage	Visibility	Housing colour	Mounting	Voltage	Article number
1		Starboard	< 50 m / < 164 ft.	1,5 W	2 nm	Black	side-mount	12 V, 24 V	3600001000
		Starboard	< 50 m / < 164 ft.	1,5 W	2 nm	White	side-mount	12 V, 24 V	3600101000
2		Port	< 50 m / < 164 ft.	1,5 W	2 nm	Black	side-mount	12 V, 24 V	3601001000
		Port	< 50 m / < 164 ft.	1,5 W	2 nm	White	side-mount	12 V, 24 V	3601101000
3		Stern	< 50 m / < 164 ft.	1,5 W	2 nm	Black	side-mount	12 V, 24 V	3602001000
		Stern	< 50 m / < 164 ft.	1,5 W	2 nm	White	side-mount	12 V, 24 V	3602101000
4		Bicolor	< 50 m / < 164 ft.	3 W	2 nm	Black	side-mount	12 V, 24 V	3603001000
		Bicolor	< 50 m / < 164 ft.	3 W	2 nm	White	side-mount	12 V, 24 V	3603101000
5		Masthead	< 20 m / < 65 ft.	4 W	3 nm	Black	side-mount	12 V, 24 V	3605001000
		Masthead	< 20 m / < 65 ft.	4 W	3 nm	White	side-mount	12 V, 24 V	3605101000
Spare Parts / Extras									
6		Cover for mounting plate Series 40 / Series 50							3600005000



## SERIES 50



Dimensions in: mm/inch

### Series 50

#### Navigation lights – Classic model made of stainless steel

##### Application

Application depending on required visibilities. See table in technical information. Lights with -symbol on European inland waterways applicable.

##### Housing

Stainless steel, impact and shock resistant, non-corrosive, non-magnetic, seawater resistant

##### Optics

Lens: Fresnel, range of visibility 2 nm (Masthead 3 or 5 nm) Material: plastic, impact resistant and shock-proof, seawater resistant

##### Protection degree

IP 56

##### Mounting

See drawing on p. 49

##### Electric

With 2-wire cable, cable entry PG 9, bulb included

1

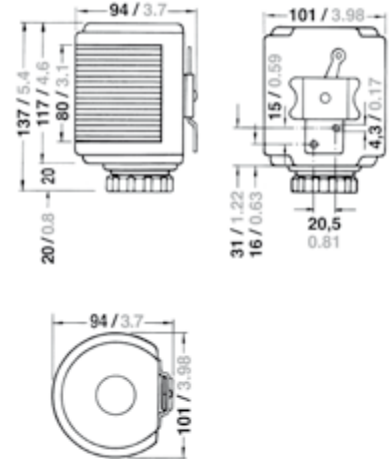

2

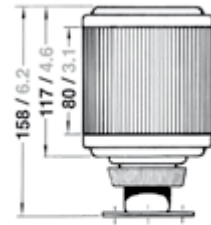

3

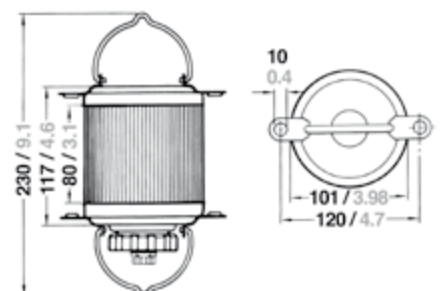
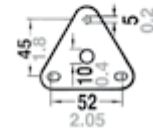









No.		Description	Ship size	Wattage	Visibility	Housing colour	Mounting	Article number 12 V	Article number 24 V
1		Starboard 	< 50 m / < 164 ft.	25 W	2 nm	Stainless steel	side-mount	3036102000	3036103000
		Port 	< 50 m / < 164 ft.	25 W	2 nm	Stainless steel	side-mount	3035202000	3035203000
		Bicolor	< 20 m / < 65 ft.	25 W	2 nm	Stainless steel	side-mount	3033302000	3033303000
		Masthead	< 20 m / < 65 ft.	25 W	3 nm	Stainless steel	side-mount	3030002000	3030003000
		Masthead white strong 	< 50 m / < 164 ft.	25 W	5 nm	Stainless steel	side-mount	3087002000	3087003000
		Stern 	< 20 m / < 65 ft.	10 W	2 nm	Stainless steel	side-mount	3034002000	3034003000
		Stern yellow 	< 20 m / < 65 ft.	10 W	2 nm	Stainless steel	side-mount	3091402000	3091403000
2		All-round white	< 20 m / < 65 ft.	10 W	2 nm	Stainless steel	deck-mount	3037012000	3037013000
		All-round white ordinary 	< 20 m / < 65 ft.	10 W	2 nm	Stainless steel	deck-mount	3086012000	3086013000
		All-round white bright 	< 20 m / < 65 ft.	25 W	2 nm	Stainless steel	deck-mount	3083012000	3083013000
		All-round red 	< 20 m / < 65 ft.	25 W	2 nm	Stainless steel	deck-mount	3038212000	3038213000
		All-round green 	< 20 m / < 65 ft.	25 W	2 nm	Stainless steel	deck-mount	3039112000	3039113000
		All-round yellow 	< 20 m / < 65 ft.	25 W	2 nm	Stainless steel	deck-mount	3058412000	3058413000
3		All-round white	< 20 m / < 65 ft.	10 W	2 nm	Stainless steel	hoistable	3037002000	3037003000
		All-round white ordinary 	< 20 m / < 65 ft.	10 W	2 nm	Stainless steel	hoistable	3086002000	3086003000
		All-round white bright 	< 20 m / < 65 ft.	25 W	2 nm	Stainless steel	hoistable	3083002000	3083003000
		All-round red 	< 20 m / < 65 ft.	25 W	2 nm	Stainless steel	hoistable	3038202000	3038203000
		All-round green 	< 20 m / < 65 ft.	25 W	2 nm	Stainless steel	hoistable	3039102000	3039103000
		All-round yellow 	< 20 m / < 65 ft.	25 W	2 nm	Stainless steel	hoistable	3058402000	3058403000
		All-round blue 	< 20 m / < 65 ft.	25 W	2 nm	Stainless steel	hoistable	3085502000	3085503000



**Spare Parts /\* Extras**  
**Ersatzteile /\* Zubehör**  
**Pièces de rechange /\* Accessoires**

- 83037010  white / weiß / blanc
- 83083017  bright / hell / clair
- 83086002  ordinary / gewöhnlich / ordinaire
- 83038002  red
- 83039002  green
- 83058002  yellow

- 83037011  white / weiß / blanc
- 83083008  bright / hell / clair
- 83086001  ordinary / gewöhnlich / ordinaire
- 83038001  red
- 83039001  green
- 83058001  yellow

- 90400002 12V/25W
- 90400003 24V/25W
- 90400005 12V/10W
- 90400006 24V/10W

83037009

95800099

83037002  
 83507003 with cable clamp / mit Kabelklemme /  
 avec borne de câble / met kabelklem / con morsetto  
 per cavi / con borne de cable / com borne para o cabo



- 83035002  red
- 83036002  green
- 83033002  yellow
- 83030003  3 n.m.
- 83087001  5 n.m.
- 83034002  red
- 83091001  yellow

63030009

\*63030012 † 160 mm / 6.3" (S)

\*39080010 † 160 mm / 6.3" (S)

\*63030011 † 195 mm / 7.7" (S)

\*3902001 (S)

\*83501004 (S)

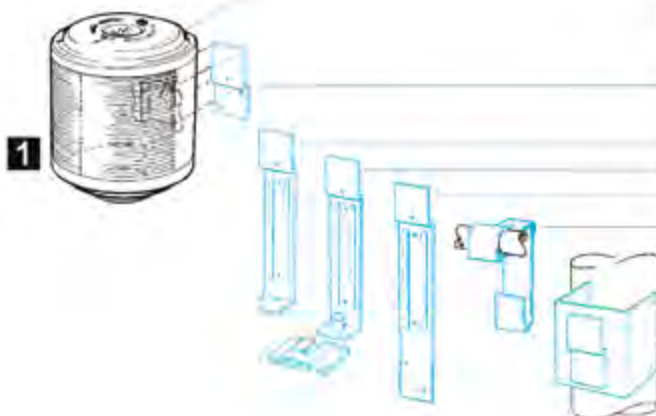

## SERIES 55



Dimensions in: mm/inch

### Series 55

#### Navigation lights – The black and white solution

##### Application

Application depending on required visibilities.  
See table in technical information.

##### Housing

Polycarbonate, impact and shock resistant,  
non-corrosive, non-magnetic, seawater  
resistant

##### Protection degree

IP 56

##### Mounting

Base flange attachment, four screws M8  
(not included)

##### Electric

Pre-wired with 1.5 m special connection cable,  
2 x 1.5 mm<sup>2</sup>, self-protective insulation, class II,  
bulb included

1

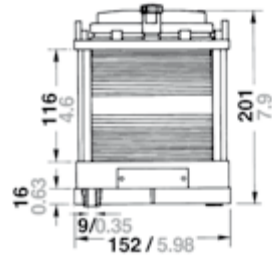
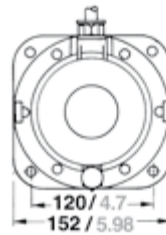

2



3

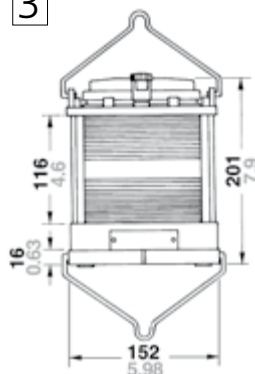
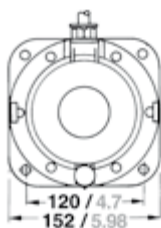



No.		Description	Ship size	Wattage	Visibility	Housing colour	Mounting	Article number 12 V	Article number 24 V
1		Starboard	> 20 m / 65 ft., < 50 m / 164 ft.	25 W	2 nm	Black	deck-mount	3535102000	3535103000
		Starboard	> 20 m / 65 ft., < 50 m / 164 ft.	25 W	2 nm	White	deck-mount	3535622000	3535623000
		Port	> 20 m / 65 ft., < 50 m / 164 ft.	25 W	2 nm	Black	deck-mount	3534202000	3534203000
		Port	> 20 m / 65 ft., < 50 m / 164 ft.	25 W	2 nm	White	deck-mount	3534622000	3534623000
		Masthead	> 20 m / 65 ft., < 50 m / 164 ft.	25 W	5 nm	Black	deck-mount	3532002000	3532003000
		Masthead	> 20 m / 65 ft., < 50 m / 164 ft.	25 W	5 nm	White	deck-mount	3532622000	3532623000
		Stern	> 20 m / 65 ft., < 50 m / 164 ft.	25 W	2 nm	Black	deck-mount	3533702000	3533703000
		Stern	> 20 m / 65 ft., < 50 m / 164 ft.	25 W	2 nm	White	deck-mount	3533622000	3533623000
		Stern yellow	> 20 m / 65 ft., < 50 m / 164 ft..	25 W	2 nm	Black	deck-mount	3533402000	3533403000
		Stern yellow	> 20 m / 65 ft., < 50 m / 164 ft.	25 W	2 nm	White	deck-mount	3533652000	3533653000
2		All-round white	> 20 m / 65 ft., < 50 m / 164 ft.	25 W	2 nm	Black	deck-mount	3531702000	3531703000
		All-round white	> 20 m / 65 ft., < 50 m / 164 ft.	25 W	2 nm	White	deck-mount	3531622000	3531623000
		All-round red	> 20 m / 65 ft., < 50 m / 164 ft.	25 W	2 nm	Black	deck-mount	3531202000	3531203000
		All-round red	> 20 m / 65 ft., < 50 m / 164 ft.	25 W	2 nm	White	deck-mount	3531632000	3531633000
		All-round green	> 20 m / 65 ft., < 50 m / 164 ft.	25 W	2 nm	Black	deck-mount	3531102000	3531103000
		All-round green	> 20 m / 65 ft., < 50 m / 164 ft.	25 W	2 nm	White	deck-mount	3531642000	3531643000

Spare Parts / Extras

3		Halyard hook						2353101000
---	--	--------------	--	--	--	--	--	------------

Spare Parts /\*Extras  
Ersatzteile /\*Zubehör  
Pièces de rechange /\*Accessoires



8353200100

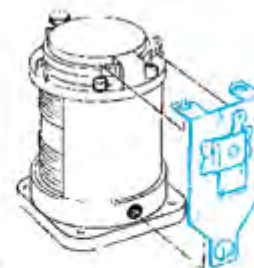
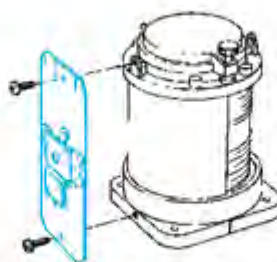

\* 83535002 (Stainless steel / Edelstahl)

\* 83533008 (Stainless steel / Edelstahl)