



TACO[®]
MARINE

RUB RAIL

Replacement
Selection Guide

FIND THE PERFECT PROFILE

Manufacturing the highest-quality
Rub Rail and marine products since 1959.

BEFORE YOU BEGIN

The TACO Marine Rub Rail Replacement Guide cross-references the original factory Rub Rail used by leading boat manufacturers since 2008. Follow these steps to find the Rub Rail that you need:

1. Look up the make of your boat.
2. Match the Rub Rail and Insert (if applicable) to your existing rail (all profiles are to scale).
3. Choose your preferred color.
4. Call a distributor or retailer to verify availability of the suggested Rub Rail, or shop online at tacomarine.com/buytacodirect.
5. Place order and get confirmation.

ESTIMATING RUB RAIL LENGTH

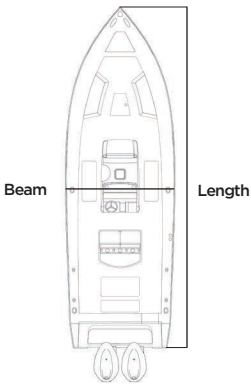

1. Take the length and width (beam) of your boat.
2. Multiply length by two and add beam.
3. This total gives you the MINIMUM length of Rub Rail required for your boat in feet.

ORIGINAL & COMPATIBLE

TACO Marine supplies the original Rub Rail to most of the builders listed in this guide. Compatible Rub Rails are provided for those boats where the builder has more than one supplier or uses a competitor's product. In most cases, the product is virtually identical and interchangeable for all practical purposes. However, on older boats, the original Rub Rail may not be the current one installed.



Handy Tips

- Ensure the length of the Rub Rail is sufficient for your boat. It is always best to buy an extra 10' for trial and error.
- Make sure to purchase all the materials needed (Rub Rail, Insert [if applicable], stainless-steel fasteners, end caps, splice caps, etc.) to complete the job.
- Carefully read all the instructions before beginning and/or watch the TACO Marine Rub Rail Installation videos available on our YouTube channel youtube.com/tacomarine and our Website tacomarine.com.
- You can replace your Rub Rail with a factory replacement style or completely different look. Regardless of the material originally installed by the builder of your boat, feel free to choose the material and style you desire.

Tools & Supplies Needed*

*not included

● RUB RAIL	● METAL FILE OR COARSE SANDPAPER TO REMOVE BURS*
● INSERT (IF REQUIRED)	● HEAT GUN (FOR RIGID VINYL RUB RAIL WITH FLEXIBLE INSERTS)*
● END CAPS (INCLUDED IN KITS)	● GARDEN SHEARS*
● MEASURING TAPE*	● MITER BOX (FOR METAL AND RIGID VINYL RUB RAIL)*
● SAFETY GOGGLES OR GLASSES*	● RUBBER Mallet*
● TWO CORDLESS DRILLS (ONE FOR A SCREW DRIVE BIT AND ONE FOR A DRILL BIT)*	● PROPER SIZE & TYPE OF SS FASTENERS (INCLUDED IN KITS)
● PUTTY KNIFE OR SCRAPER*	● WORK GLOVES*
● CAULKING GUN WITH MARINE-GRADE SEALANT OR A TUBE OF 3M 5200*	

Color Guide



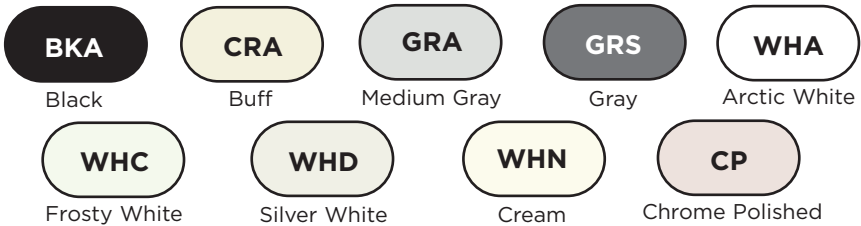







Colors specified in this catalog reflect TACO Marine's standard Rub Rail colors. Other colors are available provided minimum quantity requirements are met and sufficient lead-time is given.















Because of variations in the printing process, colors may vary slightly from the original product. Color samples available upon request.

- If you can't find the exact Rub Rail profile for your boat, we offer several universal Rub Rail kits that may work. Discover more on our website tacomarine.com.
- It is easier to install if you remember to choose a Rub Rail that is at least the same height as the original.
- Flexible vinyl Rub Rail is the easiest to bend and provides a cushioning effect when in use against normal bumps from piling and docks.
- Rigid vinyl Rub Rail, as well as aluminum Rub Rail with a flexible vinyl insert, perform well, lasts long and is easy to install in straight runs.
- Rigid vinyl Rub Rail with a stainless-steel overlap or insert provides the best protection and the longest useful life.
- SuproFlex Rub Rail is easy to install, extremely flexible and requires little-to-no heating.

BOAT BUILDERS

	Rub Rail	Page	Insert	Page
	Action Craft			
	V11-0809	45	V12-0810	54
	V11-3447	46	V12-0003	52
	V11-4014	46	V12-0003	52
	V21-9517	32	V12-0303 / V12-0307	52 / 56
	Albemarle			
	V21-9502	28	S11-4650	51
	Albury Brothers			
	V11-9990	26	V12-0307	56
	Alden Yachts			
	S11-451S	49	N/A	N/A
	S11-467S	50	N/A	N/A
	Alumacraft			
	N/A	N/A	V12-0342	53
	Aluma-Weld, Inc.			
	V11-3426	46	V12-0005	52
	V11-4014	46	V12-0003	52
	American Marine Sports			
	A11-0342	41	V12-0342	53
	V11-2423	45	V12-0003	52
	V11-3426	46	V12-0005	52
	V11-4014	46	V12-0003	52
	V11-9795	62	N/A	N/A
	V11-9798	47	S11-4511	50
	V21-9613	29	S11-4511	50
	V21-9659	29	S11-4511	50
	V21-9678	33	V12-4144	54
	V21-9811	33	V12-9809	56
	V21-9906	31	S11-4511	50
	V21-9959	31	S11-4511	50
	V21-9866	30	S11-4511	50
	Ameracat			
	V11-9990	26	V12-0307	56
	Angler			
	V11-0809	45	V12-0810	54
	V11-2423	45	V12-0003	52
	V11-4135	62	N/A	N/A
	V21-9501	32	V12-0303 / V12-0307	52 / 56
	V21-9906	31	S11-4511	50

	Rub Rail	Page	Insert	Page
	Aquasport			
	V11-2423	45	V12-0003	52
	V21-9501	32	V12-0303 / V12-0307	52 / 56
	Astro Boats			
	V21-9678	33	V12-4144	54
	Avalon & Tahoe MFG., Inc.			
	V11-9811	62	N/A	N/A
	V21-0460	35	N/A	N/A
	V21-9811	33	V12-9809	56
	Avengers Boats			
	V11-9798	47	S11-4511	50
	V21-9659	29	S11-4511	50
	V21-9811	33	V12-9809	56
	Bahama Boatworks			
	V11-9970	27	V12-9980	57
	Baja Boats			
	V21-9517	32	V12-0303 / V12-0307	52 / 56
	Bayliner			
	A11-0342	41	V12-0342	53
	A11-0347	41	V12-4155	54
	A12-0303	42	V12-0303	52
	A12-0305	42	V12-0303	52
	V11-2423	45	V12-0003	52
	V21-0188	34	N/A	N/A
	V21-3670	36	N/A	N/A
	V21-9501	32	V12-0303 / V12-0307	52 / 56
	V21-9678	33	V12-4144	54
	Belzona Marine			
	V11-9990	26	V12-0307	56
	V21-9679	30	S11-4511	50
	Bennington			
	V21-9866	30	S11-4511	50
	Bertram			
	A11-0511	43	N/A	N/A
	V21-0874	36	N/A	N/A
	Blackfin			
	V11-2423	45	V12-0003	52
	V21-0457	35	N/A	N/A
	V21-3670	36	N/A	N/A
	V21-9679	30	S11-4511	50
	V21-9866	30	S11-4511	50
	V21-9959	31	S11-4511	50

BOAT BUILDERS



Rub Rail	Page	Insert	Page
Blackwater Sport Fishing Boat			
V11-2423	45	V12-0003	52
V11-9811	62	N/A	N/A
V21-9613	29	S11-4511	50
V21-9659	29	S11-4511	50
V21-9679	30	S11-4511	50
V21-9790	30	S11-4650	51
V21-9959	31	S11-4511	50



BlackJack Saltwater Bay Boats			
V21-9678	33	V12-4144	54



Blackwood Boats			
A11-0342	41	V12-0342	53
V11-2423	45	V12-0003	52
V11-3426	46	V12-0005	52
V11-4014	46	V12-0003	52
V11-9795	62	N/A	N/A
V11-9798	47	S11-4511	50
V21-9613	29	S11-4511	50
V21-9659	29	S11-4511	50
V21-9678	33	V12-4144	54
V21-9811	33	V12-9809	56
V21-9906	31	S11-4511	50
V21-9959	31	S11-4511	50
V21-9866	30	S11-4511	50



Blazer			
V21-9659	29	S11-4511	50



Bluefin			
V11-2423	45	V12-0003	52
V21-3670	36	N/A	N/A
V21-3671	36	N/A	N/A
V21-9502	28	S11-4650	51
V21-9659	29	S11-4511	50
V21-9662	33	V12-1069	56
V21-9678	33	V12-4144	54
V21-9679	30	S11-4511	50
V21-9790	30	S11-4650	51
V21-9866	30	S11-4511	50



Blue Wave Boats			
V11-9795	62	N/A	N/A
V21-9659	29	S11-4511	50
V21-9678	33	V12-4144	54
V21-9866	30	S11-4511	50



Rub Rail	Page	Insert	Page
Bluewater Sportfishing Boats			
V11-0809	45	V12-0810	54
V11-3447	46	V12-0003	52
V21-9679	30	S11-4511	50



Bombardier			
V11-9798	47	S11-4511	50
V21-0874	36	N/A	N/A
V21-9501	32	V12-0303 / V12-0307	52 / 56



Boston Whaler			
A11-0347	41	V12-4155	54
V11-0899	45	V12-0005	52
V11-2423	45	V12-0003	52
V21-9678	33	V12-4144	54



Bryant Boats, LLC			
V11-9798	47	S11-4511	50
V21-9659	29	S11-4511	50
V21-9811	33	V12-9809	56



Buddy Davis			
A11-0152	43	N/A	N/A
V21-0874	36	N/A	N/A
V21-9613	29	S11-4511	50



Bulls Bay Boats			
V11-9798	47	S11-4511	50
V21-9659	29	S11-4511	50
V21-9811	33	V12-9809	56



Caravelle			
V21-9678	33	V12-4144	54
V21-9517	32	V12-0303 / V12-0307	52 / 56



Carolina Classic			
V21-9502	28	S11-4650	51
V21-0205	34	N/A	N/A



Carolina Composites			
V11-9798	47	S11-4511	50
V21-9659	29	S11-4511	50
V21-9811	33	V12-9809	56



Carolina Skiff			
V11-4014	46	V12-0003	52
V21-0458	35	N/A	N/A



V21-0460	35	N/A	N/A
----------	----	-----	-----



V21-9140	37	N/A	N/A
----------	----	-----	-----



V21-9613	29	S11-4511	50
----------	----	----------	----

V21-9659	29	S11-4511	50
----------	----	----------	----

BOAT BUILDERS

Rub Rail	Page	Insert	Page
V21-9662	33	V12-1069	56
V21-9811	33	V12-9809	56



Catalina Yachts

A11-0342	41	V12-0342	53
A11-0347	41	V12-4155	54
V21-9501	32	V12-0303 / V12-0307	52 / 56



Centurion Commercial Flight Parasail Boats

V11-9798	47	S11-4511	50
V21-0874	36	N/A	N/A
V21-9647	29	S11-4511	50
V21-9659	29	S11-4511	50



Century

A11-0638	42	V12-0338	53
S11-4670	51	N/A	N/A
V11-3426	46	V12-0005	52
V11-9811	62	N/A	N/A
V21-9501	32	V12-0303 / V12-0307	52 / 56
V21-9613	29	S11-4511	50
V21-9659	29	S11-4511	50
V21-9678	33	V12-4144	54



Chapparral Boats

A11-0317	41	N/A	N/A
A11-0638	42	V12-0338	53
V21-9659	29	S11-4511	50
V21-9678	33	V12-4144	54
V21-9959	31	S11-4511	50



Chris Craft Boats

A11-0152	43	N/A	N/A
V11-3161	46	V22-3162	55
V11-9669	47	S11-4690	51
V21-9659	29	S11-4511	50
V21-9811	33	V12-9809	56



Cigarette Racing Team

V11-0948	48	N/A	N/A
V11-9669	47	S11-4690	51
V21-9517	32	V12-0303 / V12-0307	52 / 56
V21-9602	32	V12-0303	52



Cobalt (aka Fiberglass Engineering)

V11-9669	47	S11-4690	51
V21-0874	36	N/A	N/A
V21-9866	30	S11-4511	50
V21-9959	31	S11-4511	50



Rub Rail	Page	Insert	Page
Cobia			
A11-0638	42	V12-0338	53
S11-4670	51	N/A	N/A
V21-9501	32	V12-0303 / V12-0307	52 / 56
V21-9678	33	V12-4144	54



Competition			
V11-9990	26	V12-0307	56



Composite Research			
A11-0151	43	N/A	N/A
A11-0342	41	V12-0342	53
V11-4014	46	V12-0003	52
V21-9659	29	S11-4511	50
V21-9662	33	V12-1069	56
V21-9959	31	S11-4511	50



Concept Boats			
V11-9669	47	S11-4690	51
V21-0460	35	N/A	N/A
V21-3670	36	N/A	N/A
V21-3671	36	N/A	N/A
V21-9602	32	V12-0303	52
V21-9662	33	V12-1069	56
V21-9678	33	V12-4144	54
V21-9679	30	S11-4511	50



Contender			
V11-2423	45	V12-0003	52
V11-3447	46	V12-0003	52
V11-4014	46	V12-0003	52
V21-3670	36	N/A	N/A
V21-9501	32	V12-0303 / V12-0307	52 / 56
V21-9517	32	V12-0303 / V12-0307	52 / 56
V21-9602	32	V12-0303	52
V21-9679	30	S11-4511	50















Correct Craft			
A11-0152	43	N/A	N/A
V11-3447	46	V12-0003	52
V11-9798	47	S11-4511	50
V21-0460	35	N/A	N/A
V21-9662	33	V12-1069	56
V21-9959	31	S11-4511	50













Crestliner			
V11-3447	46	V12-0003	52



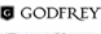





BOAT BUILDERS

	Rub Rail	Page	Insert	Page
	V21-9501	32	V12-0303 / V12-0307	52 / 56
	Crest Marine LLC			
	V11-9795	62	N/A	N/A
	N/A	N/A	V12-4144	54
	N/A	N/A	S11-4650	51
	Crevalle Boats			
	V21-9659	29	S11-4511	50
	V21-9866	30	S11-4511	50
	V21-9959	31	S11-4511	50
	Crownline			
	V21-9866	30	S11-4511	50
	Cruiser's Yachts			
	V21-9502	28	S11-4650	51
	V21-3670	36	N/A	N/A
	V21-9659	29	S11-4511	50
	Cutwater Boats			
	V21-0456	34	N/A	N/A
	V21-9517	32	V12-0303 / V12-0307	52 / 56
	Dolphin Boats			
	V11-9990	26	V12-0307	56
	Donzi			
	A11-0152	43	N/A	N/A
	V11-9669	47	S11-4690	51
	V21-9602	32	V12-0303	52
	Doral			
	V21-0188	34	N/A	N/A
	Dusky			
	V11-2423	45	V12-0003	52
	V21-1039	28	S11-4650	51
	Dynasty			
	V21-9678	33	V12-4144	54
	V21-9659	29	S11-4511	50
	E H Yachts, LLC.			
	A11-0152	43	N/A	N/A
	V21-0874	36	N/A	N/A
	V21-9613	29	S11-4511	50
	Egg Harbor Yachts			
	A11-0152	43	N/A	N/A
	V21-0874	36	N/A	N/A
	V21-9613	29	S11-4511	50
Ebbtide Boats				
	V21-9659	29	S11-4511	50













	Rub Rail	Page	Insert	Page
	V21-9678	33	V12-4144	54
	V21-9866	30	S11-4511	50
	Edenton Boatworks, LLC			
	V21-0874	36	N/A	N/A
	Edgewater			
	V11-9795	62	N/A	N/A
	V21-9502	28	S11-4650	51
	V21-9662	33	V12-1069	56
	V21-9678	33	V12-4144	54
	V21-9811	33	V12-9809	56
	Everglades Boats			
	V21-9502	28	S11-4650	51
	V21-9678	33	V12-4144	54
	V21-9866	30	S11-4511	50
	Fineline Industries			
	V11-9798	47	S11-4511	50
	V21-0874	36	N/A	N/A
	V21-9647	29	S11-4511	50
	V21-9659	29	S11-4511	50
	Fishing Holdings, LLC			
	V11-9795	62	N/A	N/A
	Fluid Motion LLC			
	V21-0456	34	N/A	N/A
	V21-9517	32	V12-0303 / V12-0307	52 / 56
	Formula			
	V21-1025	28	S11-4511	50
	V21-3671	36	N/A	N/A
	V21-9602	32	V12-0303	52
	Fountain Powerboats			
	A11-0152	43	N/A	N/A
	A11-0342	41	V12-0342	53
	V11-9990	26	V12-0307	56
	V21-3670	36	N/A	N/A
	V21-9602	32	V12-0303	52
	V21-9679	30	S11-4511	50
	Four Winns			
	A11-0638	42	V12-0338	53
	V21-1025	28	S11-4511	50
	V21-9501	32	V12-0303 / V12-0307	52 / 56
	V21-9517	32	V12-0303 / V12-0307	52 / 56
	V21-9659	29	S11-4511	50







BOAT BUILDERS

	Rub Rail	Page	Insert	Page
	V21-9662	33	V12-1069	56
	V21-9811	33	V12-9809	56
	Frontier Boats			
	V21-9678	33	V12-4144	54
	Gambler			
	V11-4014	46	V12-0003	52
	Gheenoe			
	V11-0809	45	V12-0810	54
	V21-9140	37	N/A	N/A
	Glacier Bay Catamarans			
	V11-0809	45	V12-0810	54
	V21-9501	32	V12-0303 / V12-0307	52 / 56
	V21-9659	29	S11-4511	50
	Glastron/Larson			
	A11-0638	42	V12-0338	53
	A12-0303	42	V12-0303	52
	V21-9501	32	V12-0303 / V12-0307	52 / 56
	V21-9659	29	S11-4511	50
	V21-9662	33	V12-1069	56
	V21-9811	33	V12-9809	56
	Godfrey & Dynasty			
	V21-9678	33	V12-4144	54
	V21-9659	29	S11-4511	50
	Godfrey Pontoon Boats			
	V21-9678	33	V12-4144	54
	V21-9659	29	S11-4511	50
	Grady White			
	A11-0151	43	N/A	N/A
	A50-0195	44	N/A	N/A
	V11-2423	45	V12-0003	52
	V21-9613	29	S11-4511	50
	V21-9866	30	S11-4511	50
	H C Composites LLC			
	V21-9501	32	V12-0303 / V12-0307	52 / 56
	V21-9659	29	S11-4511	50
	V21-9959	31	S11-4511	50
	HCB Yachts (Hydrasports)			
	V11-4014	46	V12-0003	52
	V21-3670	36	N/A	N/A
	Highwater Marine, LLC			
	A11-0151	43	N/A	N/A











	Rub Rail	Page	Insert	Page
	Hunter Marine			
	V11-0809	45	V12-0810	54
	V11-3161	46	V22-3162	55
	V11-9795	62	V12-4144	54
	V21-9647	29	S11-4511	50
	Hurricane			
	V21-9678	33	V12-4144	54
	V21-9659	29	S11-4511	50
	Iconic Marine Group			
	A11-0152	43	N/A	N/A
	A11-0317	41	N/A	N/A
	V11-9811	62	N/A	N/A
	V21-0205	34	N/A	N/A
	V21-9602	32	V12-0303	52
	V21-9613	29	S11-4511	50
	V21-9679	30	S11-4511	50
	V21-9790	30	S11-4650	51
	V21-9866	30	S11-4511	50
	Interceptor Performance Boats			
	V11-4014	46	V12-0003	52
	V21-9502	28	S11-4650	51
	V21-9659	29	S11-4511	50
	V21-9790	30	S11-4650	51
	V21-9959	31	S11-4511	50
	Intrepid			
	A11-0151	43	N/A	N/A
	A11-0152	43	N/A	N/A
	A50-0195	44	N/A	N/A
	V21-9659	29	S11-4511	50
	V21-9679	30	S11-4511	50
	V21-9866	30	S11-4511	50
	Invincible Boat Co.			
	A11-0152	43	N/A	N/A
	V11-2423	45	V12-0003	52
	V21-9502	28	S11-4650	51
	V21-9613	29	S11-4511	50
	Jupiter			
	V11-0809	45	V12-0810	54
	V21-9659	29	S11-4511	50
	V21-9679	30	S11-4511	50
	V21-9959	31	S11-4511	50













BOAT BUILDERS

	Rub Rail	Page	Insert	Page
	K2 Marine			
	V21-9678	33	V12-4144	54
	V21-9866	30	S11-4511	50
	Kevcon Corp./The Marine Group			
	A11-0347	41	V12-4155	54
	Key Largo			
	V21-9678	33	V12-4144	54
	Key West Boats			
	V11-4014	46	V12-0003	52
	V11-9798	47	S11-4511	50
	V21-9659	29	S11-4511	50
	V21-9662	33	V12-1069	56
	V21-9811	33	V12-9809	56
	V21-9866	30	S11-4511	50
	V21-9959	31	S11-4511	50
	Larson Boats			
	V21-9501	32	V12-0303 / V12-0307	52 / 56
	V21-9613	29	S11-4511	50
	V21-9659	29	S11-4511	50
	V21-9662	33	V12-1069	56
	Lowe Boats			
	V21-9602	32	V12-0303	52
	Luhrs			
	A11-0151	43	N/A	N/A
	A11-0152	43	N/A	N/A
	S11-451S	49	N/A	N/A
	S11-465	49	N/A	N/A
	V21-9647	29	S11-4511	50
	Mainship			
	S11-465	49	N/A	N/A
	V21-9647	29	S11-4511	50
	Mako			
	V11-0899	45	V12-0005	52
	V11-2423	45	V12-0003	52
	V21-0874	36	N/A	N/A
	V21-9517	32	V12-0303 / V12-0307	52 / 56
	V21-9790	30	S11-4650	51
	Malibu			
	N/A	N/A	V12-0307	56
	Mariah Boats			
	A11-0638	42	V12-0338	53
	V21-9501	32	V12-0303 / V12-0307	52 / 56

	Rub Rail	Page	Insert	Page
MARQUIS	Marquis Tacht LLC			
	V11-9795	62	N/A	N/A
	V11-9811	62	N/A	N/A
	V21-9501	32	V12-0303 / V12-0307	52 / 56
	V21-9866	30	S11-4511	50
MasterCraft	Mastercraft Boats			
	A11-0151	43	N/A	N/A
	A50-0195	44	N/A	N/A
	V21-3670	36	N/A	N/A
	V21-3671	36	N/A	N/A
	V21-9517	32	V12-0303 / V12-0307	52 / 56
	V21-9613	29	S11-4511	50
	V21-9662	33	V12-1069	56
	V21-9811	33	V12-9809	56
	Maverick			
	A11-0152	43	N/A	N/A
	V21-9501	32	V12-0303 / V12-0307	52 / 56
	V21-9613	29	S11-4511	50
	V21-9811	33	V12-9809	56
	V21-9866	30	S11-4511	50
	Maxum			
	A11-0342	41	V12-0342	53
	A11-0347	41	V12-4155	54
	A12-0303	42	V12-0303	52
	A12-0305	42	V12-0303	52
	V11-2423	45	V12-0003	52
	V21-0188	34	N/A	N/A
	V21-3670	36	N/A	N/A
	V21-9501	32	V12-0303 / V12-0307	52 / 56
May-Craft	May Craft Fiberglass Products, Inc.			
	V21-0205	34	N/A	N/A
	V21-9517	32	V12-0303 / V12-0307	52 / 56
	V21-9613	29	S11-4511	50
	V21-9659	29	S11-4511	50
	V21-9662	33	V12-1069	56
	V21-9678	33	V12-4144	54
	V21-9679	30	S11-4511	50
	V21-9811	33	V12-9809	56
	Mckee Craft			
	V21-9678	33	V12-4144	54
	V11-3161	46	V22-3162	55
	Midnight Express			
	V11-2423	45	V12-0003	52

BOAT BUILDERS

	Rub Rail	Page	Insert	Page
	V11-9990	26	V12-0307	56
	V21-0205	34	N/A	N/A
	V21-0874	36	N/A	N/A
	V21-9602	32	V12-0303	52
	V21-9613	29	S11-4511	50
	V21-9790	30	S11-4650	51
	Misty Harbor Pontoons			
	A11-0347	41	V12-4155	54
	Monterey Boats / Sebring Marine			
	V21-9501	32	V12-0303 / V12-0307	52 / 56
	V21-9659	29	S11-4511	50
	V21-9679	30	S11-4511	50
	V21-9811	33	V12-9809	56
	Nautic Star			
	V11-9798	47	S11-4511	50
	V21-9662	33	V12-1069	56
	V21-9866	30	S11-4511	50
	V21-9959	31	S11-4511	50
	Nitro			
	V21-9678	33	V12-4144	54
	OBX Boatworks			
	V11-9990	26	V12-0307	56
	Ovation Yachts			
	A11-0152	43	N/A	N/A
	V21-0874	36	N/A	N/A
	V21-9613	29	S11-4511	50
	Palm Beach Fishing Boats			
	V21-9678	33	V12-4144	54
	Parker			
	A11-0152	43	N/A	N/A
	V21-9866	30	S11-4511	50
	V21-9959	31	S11-4511	50
	Pioneer			
	V11-9798	47	S11-4511	50
	V21-9659	29	S11-4511	50
	V21-9811	33	V12-9809	56
	Polar Kraft			
	V21-9678	33	V12-4144	54
	V21-9659	29	S11-4511	50
	Predator Yachts			
	A11-0152	43	N/A	N/A
	V21-0874	36	N/A	N/A
	V21-9613	29	S11-4511	50

	Rub Rail	Page	Insert	Page
	Pro Sport Boats			
	V21-9662	33	V12-1069	56
	Pro-Line Boats			
	A11-0152	43	N/A	N/A
	V11-9669	47	S11-4690	51
	V21-3670	36	N/A	N/A
	V21-9602	32	V12-0303	52
	V21-9678	33	V12-4144	54
	V21-9866	30	S11-4511	50
	Pursuit			
	A11-0152	43	N/A	N/A
	V11-3161	46	V22-3162	55
	V21-9613	29	S11-4511	50
	V21-9790	30	S11-4650	51
	V21-9866	30	S11-4511	50
	V21-9959	31	S11-4511	50
	Ranger			
	N/A	N/A	V12-4144	54
	N/A	N/A	V12-0003	52
	N/A	N/A	V12-9787	55
	Ranger Tug			
	V21-0456	34	N/A	N/A
	V21-9517	32	V12-0303 / V12-0307	52 / 56
	R.J. Dougherty & Assoc. Inc.			
	V11-0899	45	V12-0005	52
	V11-4014	46	V12-0003	52
	V21-9502	28	S11-4650	51
	V21-9602	32	V12-0303	52
	V21-9613	29	S11-4511	50
	V21-9866	30	S11-4511	50
	Rec Boat Holdings LLC			
	V21-9501	32	V12-0303 / V12-0307	52 / 56
		29	S11-4511	50
		33	V12-9809	56
	Recreation Unlimited LLC			
	V11-4014	46	V12-0003	52
		28	S11-4650	51
	V21-9659	29	S11-4511	50
		30	S11-4650	51
	V21-9959	31	S11-4511	50
	Reef Runner			
	V11-9990	26	V12-0307	56

BOAT BUILDERS



Regal	Rub Rail	Page	Insert	Page
Regal Marine				
	A11-0152	43	N/A	N/A
	V11-2423	45	V12-0003	52
	V11-3447	46	V12-0003	52
	V21-0460	35	N/A	N/A
	V21-1025	28	S11-4511	50
	V21-9501	32	V12-0303 / V12-0307	52 / 56
	V21-9502	28	S11-4650	51
	V21-9613	29	S11-4511	50
	V21-9659	29	S11-4511	50
	V21-9811	33	V12-9809	56
	V21-9959	31	S11-4511	50



Release Boats LLC	Rub Rail	Page	Insert	Page
Release Boats LLC				
	V11-0899	45	V12-0005	52
	V11-2423	45	V12-0003	52
	V11-3447	46	V12-0003	52
	V11-4014	46	V12-0003	52
	V11-9795	62	N/A	N/A
	V11-9811	62	N/A	N/A
	V11-9960	27	V12-0307	56
	V21-9517	32	V12-0303 / V12-0307	52 / 56
	V21-9659	29	S11-4511	50
	V21-9679	30	S11-4511	50
	V21-9811	33	V12-9809	56
	V21-9866	30	S11-4511	50
	V21-9959	31	S11-4511	50



Renaissance Prowler LLC	Rub Rail	Page	Insert	Page
Renaissance Prowler LLC				
	V11-2423	45	V12-0003	52
	V11-9811	62	N/A	N/A
	V11-9990	26	V12-0307	56
	V21-3671	36	N/A	N/A
	V21-9602	32	V12-0303	52
	V21-9662	33	V12-1069	56



Rinker	Rub Rail	Page	Insert	Page
Rinker				
	V21-0460	35	N/A	N/A
	V21-9659	29	S11-4511	50













Robalo	Rub Rail	Page	Insert	Page
Robalo				
	V11-2423	45	V12-0003	52
	V21-9678	33	V12-4144	54



Robertson and Caine	Rub Rail	Page	Insert	Page
Robertson and Caine				
	V11-9811	62	N/A	N/A



S2 Yachts, Inc	Rub Rail	Page	Insert	Page
S2 Yachts, Inc				
	A11-0638	42	V12-0338	53

	Rub Rail	Page	Insert	Page
	V21-1039	28	S11-4650	51
	V21-9790	30	S11-4650	51
	Sailfish Boats			
	V21-9501	32	V12-0303 / V12-0307	52 / 56
	V21-9659	29	S11-4511	50
	V21-9678	33	V12-4144	54
	V21-9679	30	S11-4511	50
	Scarab			
	V21-3670	36	N/A	N/A
	Scout			
	V11-2423	45	V12-0003	52
	V11-3447	46	V12-0003	52
	V21-9906	31	S11-4511	50
	V21-9959	31	S11-4511	50
	Sea Boss			
	V21-9678	33	V12-4144	54
	V21-9659	29	S11-4511	50
SeaCraft	SeaCraft			
	V21-9679	30	S11-4511	50
	Sea Chaser			
	V21-9659	29	S11-4511	50
	Sea Fox			
	V11-9798	47	S11-4511	50
	Sea Hunt			
	V11-2423	45	V12-0003	52
	V21-9866	30	S11-4511	50
	Sea Pro			
	V11-9798	47	S11-4511	50
	V21-9959	31	S11-4511	50
	Sea Ray Boats			
	A11-0151	43	N/A	N/A
	V11-3447	46	V12-0003	52
	V21-0188	34	N/A	N/A
	V21-1025	28	S11-4511	50
	V21-9501	32	V12-0303 / V12-0307	52 / 56
	V21-9517	32	V12-0303 / V12-0307	52 / 56
	V21-9613	29	S11-4511	50
	N/A	N/A	S11-4511	50
	N/A	N/A	S11-4690	51
	V21-9679	30	S11-4511	50
	V21-9811	33	V12-9809	56
	Sea Swirl			
	V21-9501	32	V12-0303 / V12-0307	52 / 56

BOAT BUILDERS



Rub Rail	Page	Insert	Page
Sea Vee			
A11-0152	43	N/A	N/A
A11-0511	43	N/A	N/A
V11-0948	48	N/A	N/A
V11-9970	27	V12-9980	57
V11-9990	26	V12-0307	56
V21-0874	36	N/A	N/A
V21-9613	29	S11-4511	50
V21-9659	29	S11-4511	50



Seabring Marine Industries Inc			
A11-0342	41	V12-0342	53
V21-9613	29	S11-4511	50
V21-9659	29	S11-4511	50
V21-9679	30	S11-4511	50
V21-9941	37	N/A	N/A



Seahunter			
A11-0638	42	V12-0338	53
V11-0809	45	V12-0810	54
V11-0899	45	V12-0005	52
V11-2423	45	V12-0003	52
V11-4014	46	V12-0003	52
V11-9795	62	N/A	N/A
V21-0205	34	N/A	N/A
V21-0874	36	N/A	N/A
V21-9501	32	N/A	N/A
V21-9502	28	S11-4650	51
V21-9613	29	S11-4511	50
V21-9678	33	V12-4144	54
V21-9790	30	S11-4650	51









Seminole Marine, Inc.			
V11-0899	45	V12-0005	52
V21-0874	36	N/A	N/A
V21-9659	29	S11-4511	50
V21-9678	33	V12-4144	54
V21-9679	30	S11-4511	50
V21-9866	30	S11-4511	50



Shallow Sport			
V21-9659	29	S11-4511	50
V21-9678	33	S11-4511	50









Shamrock			
A11-0514	43	N/A	N/A
V21-9679	30	S11-4511	50

	Rub Rail	Page	Insert	Page
	Shearwater			
	V11-9990	26	V12-0307	56
	V21-9502	28	S11-4650	51
	Silverton			
	A11-0152	43	N/A	N/A
	V21-9647	29	S11-4511	50
	V21-9678	33	V12-4144	54
	Skeeter			
	V21-9866	30	S11-4511	50
	Southwind			
	V21-9659	29	S11-4511	50
	V21-9678	33	V12-4144	54
	Sport Craft			
	A11-0342	41	V12-0342	53
	V21-9501	32	V12-0303	52
	V21-9602	32	V12-0303	52
	Sportsman			
	V11-0809	45	V12-0810	54
	V21-9659	29	S11-4511	50
	V21-9679	30	S11-4511	50
	V21-9959	31	S11-4511	50
	V21-9811	33	V12-9809	56
	V21-9866	30	S11-4511	50
	Stamas Yacht, Inc.			
	V21-9959	31	S11-4511	50
	Starcraft			
	V21-9678	33	V12-4144	54
	Sterling Flats Boats			
	A11-0342	41	V12-0342	53
	V11-2423	45	V12-0003	52
	V11-3426	46	V12-0005	52
	V11-4014	46	V12-0003	52
	V11-9795	62	N/A	N/A
	V11-9798	47	S11-4511	50
	V21-9613	29	S11-4511	50
	V21-9659	29	S11-4511	50
	V21-9678	33	V12-4144	54
	V21-9811	33	V12-9809	56
	V21-9906	31	N/A	N/A
	V21-9959	31	S11-4511	50
	V21-9866	30	S11-4511	50

BOAT BUILDERS

	Rub Rail	Page	Insert	Page
	Stingray			
	V21-9659	29	S11-4511	50
	Stratos Boats			
	V21-9659	29	S11-4511	50
	Stuart Marine			
	V11-3161	46	V22-3162	55
	Streamline			
	V11-9970	27	V12-9980	57
	Sunbird			
	V21-9501	32	V12-0303	52
	Sundance			
	V21-9659	29	S11-4511	50
	V21-9959	31	S11-4511	50
	Supra			
	V21-9678	33	V12-4144	54
	Supreme World Class Towboats			
	V11-9798	47	S11-4511	50
	V21-0874	36	N/A	N/A
	V21-9647	29	S11-4511	50
	V21-9659	29	S11-4511	50
	Tahoe Boats			
	A12-0303	42	V12-0303	52
	V21-9501	32	V12-0303	52
	Tennessee Watercraft / Yamaha			
	V21-9517	32	V12-0303 / V12-0307	52 / 56
	V21-9659	29	S11-4511	50
	Thunder Powerboats			
	V21-3670	36	N/A	N/A
	Thunderbird			
	A11-0151	43	N/A	N/A
	A11-0152	43	N/A	N/A
	V11-3447	46	V12-0003	52
	V21-1025	28	S11-4511	50
	V21-9602	32	V12-0303	52
	V21-9959	31	S11-4511	50
	Tiara			
	V11-2423	45	V12-0003	52
	V21-1039	28	S11-4650	51
	Tidewater			
	V11-9795	62	N/A	N/A
	V21-9659	29	S11-4511	50
	V21-9679	30	S11-4511	50

	Rub Rail	Page	Insert	Page
	V21-9906	31	N/A	N/A
	V21-9959	31	S11-4511	50
	Tige Boats			
	V11-9795	62	N/A	N/A
	V11-9798	47	S11-4511	50
	V11-9811	62	N/A	N/A
	V21-9662	33	V12-1069	56
	V21-9790	30	S11-4650	51
	V21-9811	33	V12-9809	56
	V21-9906	31	S11-4511	50
	V21-9959	31	S11-4511	50
	Topaz Boats			
	A11-0152	43	N/A	N/A
	V21-0874	36	N/A	N/A
	V21-9613	29	S11-4511	50
	Tracker Boats			
	V11-9752	47	S11-4650	51
	V21-0874	36	N/A	N/A
	V21-9517	32	V12-0303	52
	V21-9679	30	S11-4511	50
	V21-9790	30	S11-4650	51
	V21-9811	33	N/A	N/A
	Triton Boats			
	V11-9795	62	V12-4144	54
	N/A	N/A	V12-1069	56
	V21-9790	30	S11-4650	51
	Triumph Boats			
	V21-9662	33	V12-1069	56
	Trophy			
	A11-0342	41	V12-0342	53
	A11-0347	41	V12-4155	54
	A12-0303	42	V12-0303	52
	A12-0305	42	V12-0303	52
	V11-2423	45	V12-0003	52
	V21-0188	34	N/A	N/A
	V21-3670	36	N/A	N/A
	V21-9501	32	V12-0303	52
	V21-9678	33	V12-4144	54
	Twin Vee Catamarans, Inc.			
	A11-0151	43	N/A	N/A
	A11-0514	43	N/A	N/A
	V11-9990	26	V12-0307	56

BOAT BUILDERS



Rub Rail	Page	Insert	Page
V21-0874	36	N/A	N/A
V21-9602	32	V12-0303	52
V21-9659	29	N/A	N/A
V21-9662	33	V12-1069	56
V21-9678	33	V12-4144	54
V21-9679	30	S11-4511	50
V21-9790	30	S11-4650	51
V21-9811	33	N/A	N/A
V21-9866	30	S11-4511	50
V21-9959	31	S11-4511	50
VELOCITY POWERBOATS			
Velocity			
V21-9678	33	V12-4144	54
VENTURE			
V11-0899	45	V12-0005	52
N/A	N/A	S11-4650	51
viking yachts			
Viking Yacht Company			
V11-2423	45	V12-0003	52
V11-3426	46	V12-0005	52
V21-9959	31	S11-4511	50
BOATS			
VIP			
V21-0188	34	N/A	N/A
V21-9678	33	V12-4144	54
V21-9866	30	S11-4511	50
Wahou			
V21-9678	33	V12-4144	54
WARLOCK			
Warlock			
V21-3670	36	N/A	N/A
Wellcraft			
Wellcraft Marine			
A11-0317	41	V12-0317	53
V11-0899	45	V12-0005	52
V21-1025	28	S11-4511	50
V21-3670	36	N/A	N/A
V21-3671	36	N/A	N/A
V21-9501	32	V12-0303	52
V21-9647	29	S11-4511	50
V21-9659	29	S11-4511	50
V21-9678	33	V12-4144	54
WORLD CAT			
World Cat			
V21-9501	32	V12-0303 / V12-0307	52 / 56
V21-9659	29	S11-4511	50
V21-9959	31	S11-4511	50

Rub Rail	Page	Insert	Page
World Class Catamarans			
V21-9659	29	S11-4511	50
V21-9662	33	V12-1069	56
V21-9501	32	V12-0303 / V12-0307	52 / 56
V21-9959	31	S11-4511	50
Yamaha			
V21-9517	32	V12-0303 / V12-0307	52 / 56
V21-9659	29	S11-4511	50
V21-9679	30	S11-4511	50
Yellowfin			
V11-9990	26	V12-0307	56





ACCEPTS FLEX CHROME

Introducing the future of hull protection with the new family of SuproFlex Rub Rail – lightweight, ultra-flexible profiles to save you time and money while providing a seamless precision fit.

V11-9990

Insert: V12-0307CP, V12-0307BP

Part Number	Color	Length	Screw
V11-9990BKA60D	Black / Flex Chrome	60'	#10
V11-9990WHA60D	Arctic White / Flex Chrome	60'	#10
V11-9990WHC60D	Frosty White / Flex Chrome	60'	#10
V11-9990BKA80D	Black / Flex Chrome	80'	#10
V11-9990WHA80D	Arctic White / Flex Chrome	80'	#10
V11-9990WHC80D	Frosty White / Flex Chrome	80'	#10

AVAILABLE AS A RUB RAIL KIT (pg. 63)

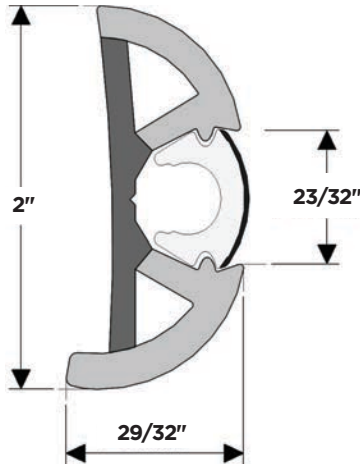

V11-9970

Insert: V12-9980CP Flex Chrome

Part Number	Color	Length	Screw
V11-9970BKA100D	Black / Flex Chrome	100'	#10
V11-9970WHA100D	Arctic White / Flex Chrome	100'	#10

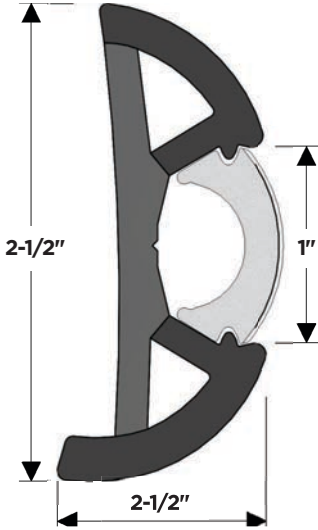

V11-9960

Insert: V12-0307CP, V12-0307BP

Part Number	Color	Length	Screw
V11-9960BKA60D	Black / Flex Chrome	60'	#10

AVAILABLE AS A RUB RAIL KIT (pg. 63)

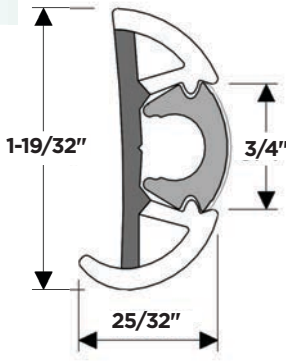

RIGID VINYL

RIGID VINYL - ACCEPTS STAINLESS-STEEL INSERT

V21-1025

Insert: S11-4511

Part Number	Color	Length	Screw*
V21-1025WHC20D	Frosty White	20'	#10

*Drilled and countersunk on 6" centers / sold separately

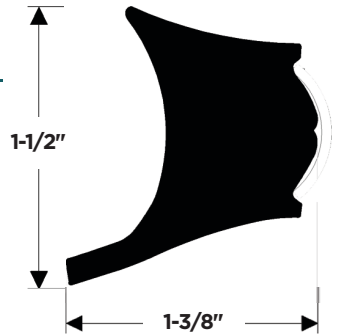

V21-1039

Insert: S11-4650

Part Number	Color	Length	Screw*
V21-1039BKA20D1	Black	20'	#8

*Drilled and countersunk on 12" centers / sold separately

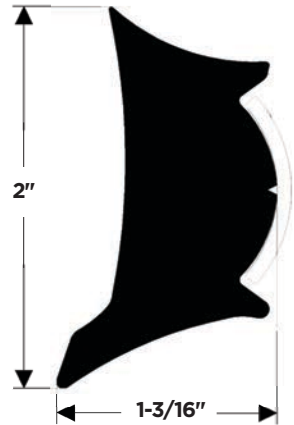

V21-9502

Insert: S11-4650

Part Number	Color	Length	Screw*
V21-9502BKA20D	Black	20'	#8
V21-9502WHC20D	Frosty White	20'	#8

*Drilled and countersunk on 8" centers / sold separately

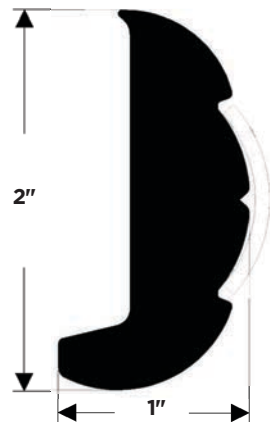

RIGID VINYL ACCEPTS STAINLESS-STEEL INSERT

V21-9613

Insert: S11-4511

Part Number	Color	Length	Screw*
V21-9613BGZ12D	Blue	12	#8
V21-9613BGZ16D	Blue	16	#8
V21-9613BGZ18D	Blue	18	#8
V21-9613WHC20D	White	20	#8

*Drilled and countersunk on 7" centers / sold separately

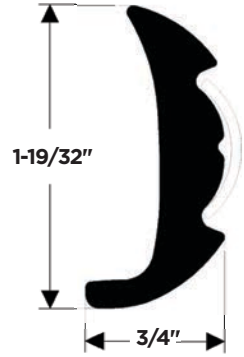

V21-9647

Insert: S11-4511

Part Number	Color	Length	Screw*
V21-9647WHA20D	Arctic White	20'	#10

*Drilled and countersunk on 12" centers / sold separately

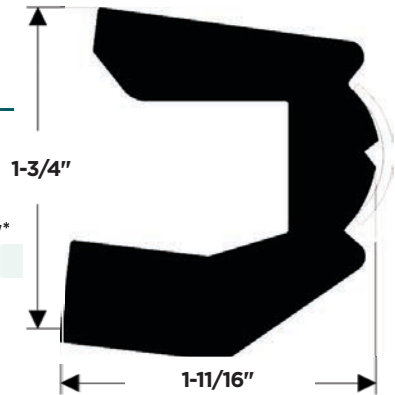

V21-9659

Insert: S11-4511

Part Number	Color	Length	Screw*
V21-9659WHC16D	Frosty White	16'	#8
V21-9659WHC20D	Frosty White	20'	#8
V21-9659BKA16.25D	Black	16.25'	#8
V21-9659BKA20D	Black	20'	#8

*Drilled and countersunk on 8" centers / sold separately

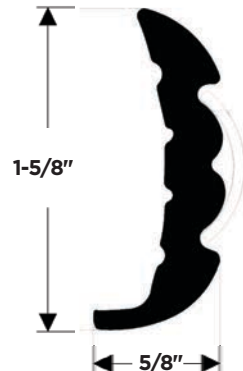

PAIRS WITH LED NAV. LIGHTS (PG. 60)

RIGID VINYL ACCEPTS STAINLESS-STEEL INSERT

V21-9679

Insert: S11-4511

Part Number	Color	Length	Screw*
V21-9679BKA20D	Black	20'	#8
V21-9679WHC20D	Frosty White	20'	#8

*Drilled and countersunk on 8" centers / sold separately

PAIRS WITH LED NAV. LIGHTS (PG. 60)



V21-9790

Insert: S11-4650

Part Number	Color	Length	Screw*
V21-9790BKA20D	Black	20'	#10

*Drilled and countersunk on 8" centers / sold separately

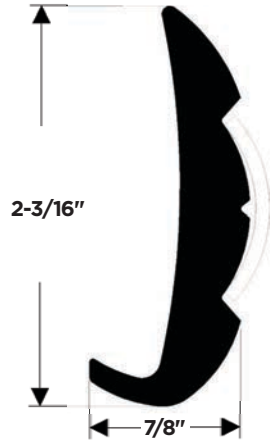

V21-9866

Insert: S11-4511

Part Number	Color	Length	Screw*
V21-9866WHC20D	Frosty White	20'	#8

*Drilled and countersunk on 8" centers / sold separately

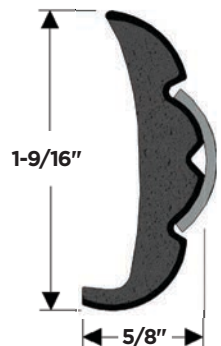

RIGID VINYL ACCEPTS STAINLESS-STEEL INSERT

V21-9906

Insert: S11-4511

Part Number	Color	Length	Screw*
V21-9906BKA60D	Black	60'	#8
V21-9906WHC20D	Frosty White	20'	#8
V21-9906WHC60D	Frosty White	60'	#8
V21-9906WHC65D	Frosty White	65'	#8

*Drilled and countersunk on 8" centers / sold separately

PAIRS WITH LED NAV. LIGHTS (PG. 60)

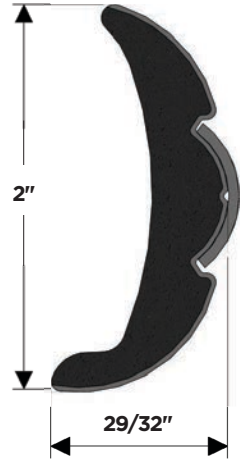

V21-9959

Insert: S11-4511

Part Number	Color	Length	Screw*
V21-9959BKA20D	Black	20'	#8
V21-9959BKA60D	Black	60'	#8
V21-9959WHC20D	Frosty White	20'	#8
V21-9959WHC45D	Frosty White	45'	#8
V21-9959WHC50	Frosty White	50'	#8
V21-9959WHC60D	Frosty White	60'	#8

*Drilled and countersunk on 8" centers / sold separately

PAIRS WITH LED NAV. LIGHTS (PG. 60)

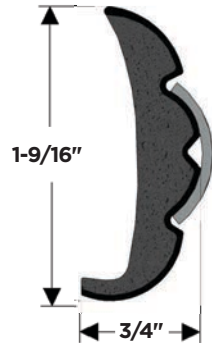

RIGID VINYL ACCEPTS FLEXIBLE INSERT

V21-9501

Insert: V12-0303, V12-0307CP

Part Number	Color	Length	Screw*
V21-9501WHC20D	Frosty White	20'	#10

*Drilled and countersunk on 6" centers / sold separately

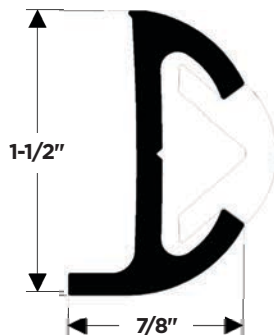

V21-9517

Insert: V12-0303, V12-0307CP

Part Number	Color	Length	Screw*
V21-9517BKA20D	Black	20'	#10

*Drilled and countersunk on 6" centers / sold separately

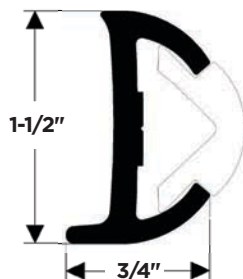

V21-9602

Insert: V12-0303

Part Number	Color	Length	Screw*
V21-9602WHA20D	Arctic White	20'	#10

*Drilled and countersunk on 8" centers / sold separately

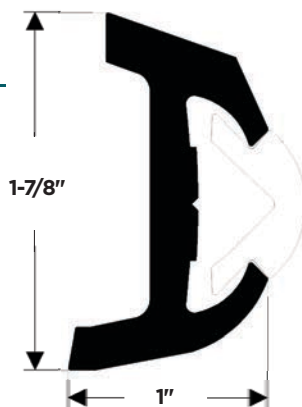

RIGID VINYL ACCEPTS FLEXIBLE INSERT

V21-9678

Insert: V12-4144

Part Number	Color	Length	Screw*
V21-9678BKA20D	Black	20'	#8
V21-9678WHA20D	Black	20'	#8

*Drilled and countersunk on 6" centers / sold separately

PAIRS WITH LED NAV. LIGHTS (PG. 60)

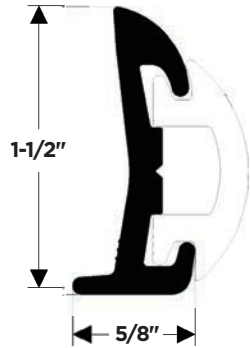

V21-9662

Insert: V12-1069CP

Part Number	Color	Length	Screw*
V21-9662WHC20D	Frosty White	20'	#8

*Drilled and countersunk on 8" centers / sold separately

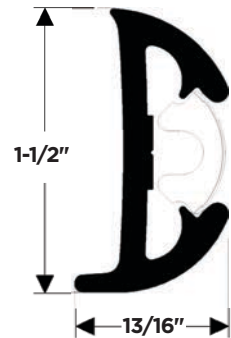

V21-9811

Insert: V12-9809CP

Part Number	Color	Length	Screw*
V21-9811BKA20D	Black	20'	#8
V21-9811WHD20D	Silver White	20'	#8

*Drilled and countersunk on 8" centers / sold separately

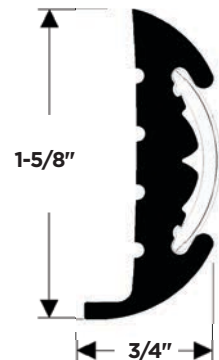

RIGID VINYL WITH NO INSERT

V21-0188

Part Number	Color	Length	Screw*
V21-0188BKA20D	Black	20'	#8

*Drilled and countersunk on 6" centers / sold separately

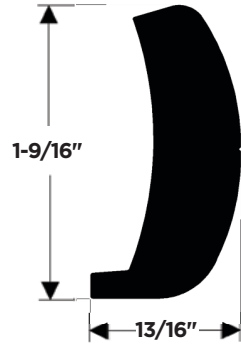

V21-0205

Part Number	Color	Length	Screw*
V21-0205BKA20D	Black	20'	#10

*Drilled and countersunk on 8" centers / sold separately

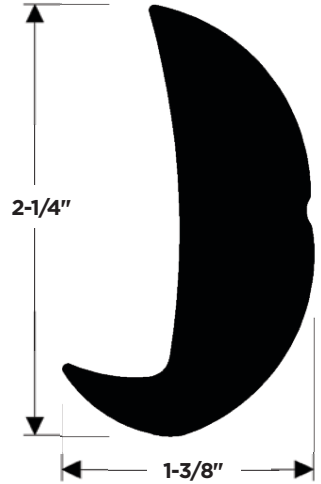

V21-0456

Part Number	Color	Length	Screw*
V21-0456BKA12D	Black	12'	#8

*Drilled and countersunk on 6" centers / sold separately

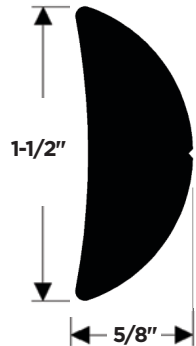

RIGID VINYL WITH NO INSERT

V21-0457

Part Number	Color	Length	Screw*
V21-0457BKA20D	Black	20'	#8

*Drilled and countersunk on 6" centers / sold separately

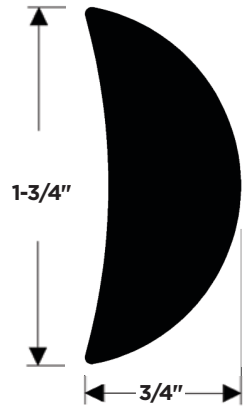

V21-0458

Part Number	Color	Length	Screw*
V21-0458BKA20D	Black	20'	#10

*Drilled and countersunk on 6" centers / sold separately

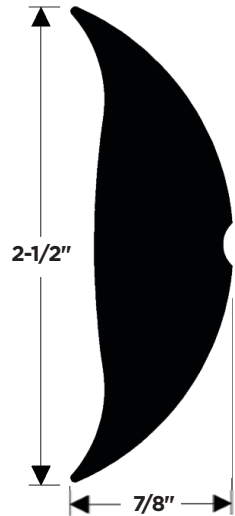

V21-0460

Part Number	Color	Length	Screw*
V21-0460BKA12D	Black	12'	#6

*Drilled and countersunk on 6" centers / sold separately

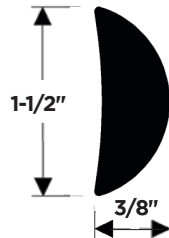

RIGID VINYL WITH NO INSERT

V21-0874

Part Number	Color	Length	Screw*
V21-0874WHA18	Arctic White	18'	#10

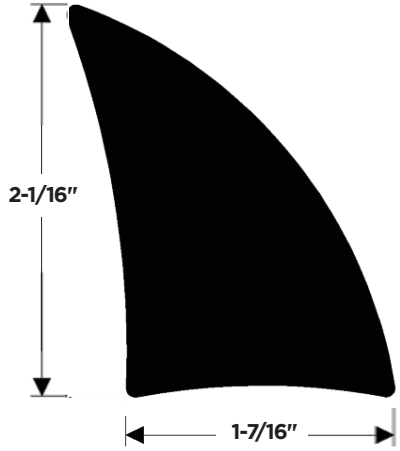

V21-3670

Part Number	Color	Length	Screw*
V21-3670BKA20D	Black	20'	#10
V21-3670WHA20D	Arctic White	20'	#10
V21-3670BKA20D-1	Black	20'	#10
V21-3670BKA20D-1A	Black	20'	#10

*Drilled and countersunk on 8" centers / sold separately

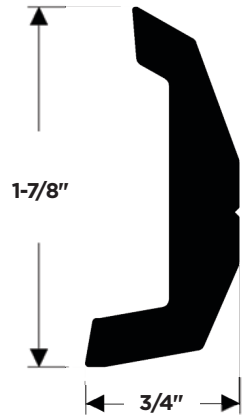

V21-3671

Part Number	Color	Length	Screw*
V21-3671BKA20D	Black	20'	#10
V21-3671WHA20D	Arctic White	20'	#10

*Drilled and countersunk on 8" centers / sold separately

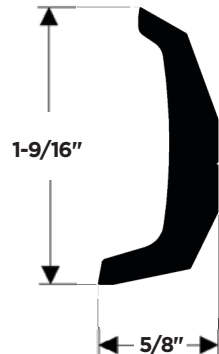

V21-9140

Part Number	Color	Length	Screw*
V21-9140BKA166	Black	16'6"	#8

*Self-tapping screws, bolts or pop rivets can be used / sold separately

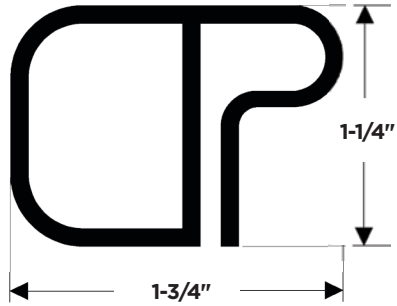

V21-9941

Part Number	Color	Length	Screw*
V21-9941WHA20	Arctic White	20'	N/A*

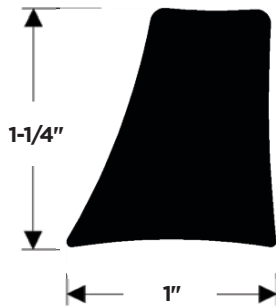

*Does not come pre-drilled. Screws are up to customer discretion.

RIGID VINYL COMMERICAL RUB RAIL

V21-9938

Part Number	Color	Length	Screw*
V21-9938BKA20	Black	20'	N/A*
V21-9938WHA20	Arctic White	20'	N/A*

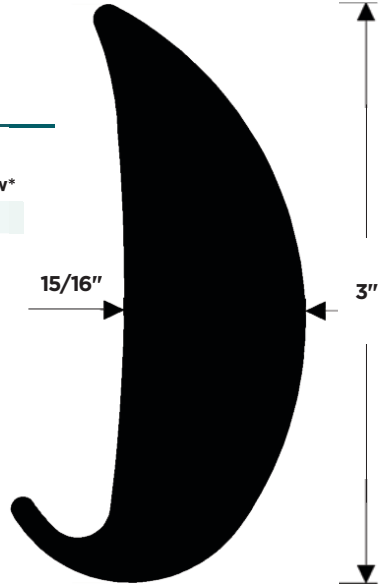

V21-9939

Part Number	Color	Length	Screw*
V21-9939BKA20	Black	20'	N/A*
V21-9939WHA20	Arctic White	20'	N/A*

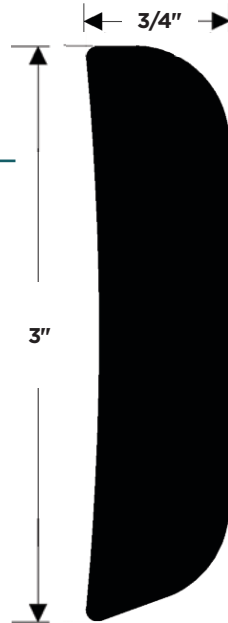

*Does not come pre-drilled. Screws are up to customer discretion.

RIGID VINYL COMMERICAL RUB RAIL

V21-9940

Part Number	Color	Length	Screw*
V21-9940BKA20	Black	20'	N/A*
V21-9940WHA20	Arctic White	20'	N/A*

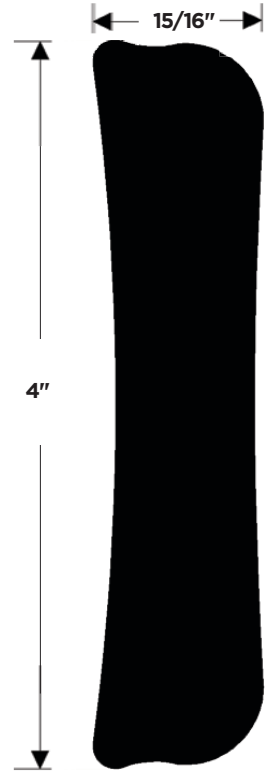

V21-9942

Part Number	Color	Length	Screw*
V21-9942BKA20	Black	20'	N/A*
V21-9942WHA20	Arctic White	20'	N/A*

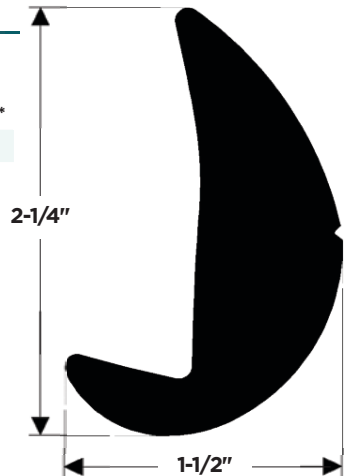

*Does not come pre-drilled. Screws are up to customer discretion.

RIGID VINYL COMMERCIAL RUB RAIL

V21-9953

Part Number	Color	Length	Screw*
V21-9953BKA20	Black	20'	N/A*

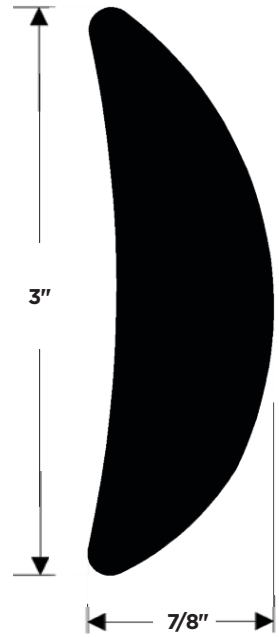

V21-9954

Part Number	Color	Length	Screw*
V21-9954BKA20	Black	20'	N/A*
V21-9954WHA20	Arctic White	20'	N/A*

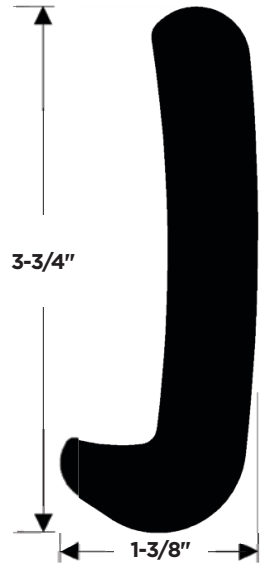

*Does not come pre-drilled. Screws are up to customer discretion.

ALUMINUM / STAINLESS STEEL

ANODIZED ALUMINUM - ACCEPTS FLEXIBLE INSERT

A11-0317

Insert: V12-0317

Part Number	Color	Length	Screw*
A11-0317TAL12D	Polished Clear	12'	#8

*Drilled and countersunk on 6" centers / sold separately

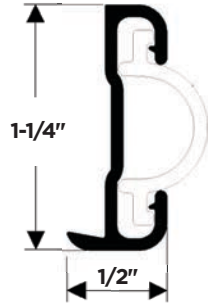

A11-0342

Insert: V12-0342

Part Number	Color	Length	Screw*
A11-0342BLY12D	Polished Clear	12'	#8

*Drilled and countersunk on 6" centers / sold separately

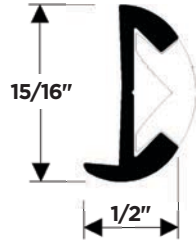

A11-0347

Insert: V12-4155, V12-9787

Part Number	Color	Length	Screw*
A11-0347BLY12D	Brite	12'	#8

*Drilled and countersunk on 6" centers / sold separately

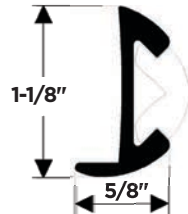

ANODIZED ALUMINUM ACCEPTS FLEXIBLE INSERT

A11-0638

Insert: V12-0338

Part Number	Color	Length	Screw*
A11-0638TAL12D	Polished Clear	12'	#8

*Drilled and countersunk on 6" centers / sold separately

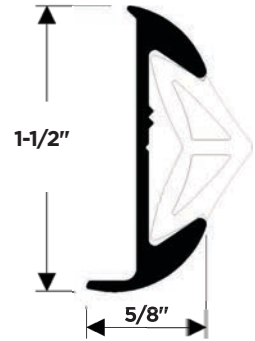

A12-0303

Insert: V12-0303

Part Number	Color	Length	Screw*
A12-0303BLY12D	Brite Anodized	12'	#10

*Drilled and countersunk on 6" centers / sold separately

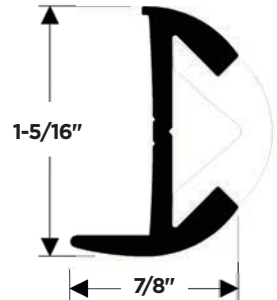

A12-0305

Insert: V12-0303

Part Number	Color	Length	Screw*
A12-0305BLY12D	Polished Clear	12'	#10

*Drilled and countersunk on 6" centers / sold separately

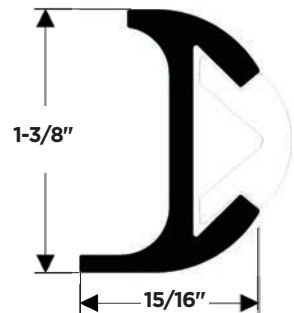

ANODIZED ALUMINUM WITH NO INSERT

A11-0151

Part Number	Color	Length	Screw*
A11-0151TAL12D	Anodized	12'	#8

*Drilled and countersunk on 6" centers / sold separately

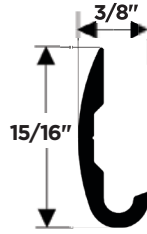

A11-0152

Part Number	Color	Length	Screw*
A11-0152TAL12D-A	Polished Clear	12'	#8

*Drilled and countersunk on 6" centers / sold separately

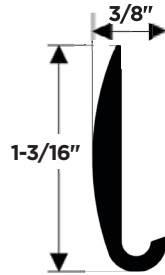

A11-0511

Part Number	Color	Length	Screw*
A11-0511TAL20D	Polished Clear	20'	#10

*Drilled and countersunk on 6" centers / sold separately

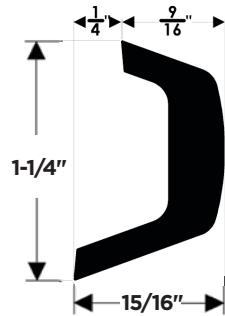

A11-0514

Part Number	Color	Length	Screw*
A11-0514TAL20D	Polished Clear	20'	#10

*Drilled and countersunk on 6" centers / sold separately

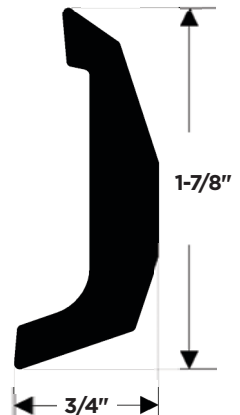

ANODIZED ALUMINUM WITH NO INSERT

A50-0195

Part Number	Color	Length	Screw*
A50-0195TAL12D	Polished Clear	12'	#5

*Drilled and countersunk on 6" centers / sold separately

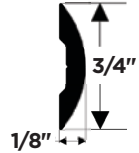

A50-0197

Part Number	Color	Length	Screw*
A50-0197TAL12D	Polished Clear	12'	#6

*Drilled and countersunk on 6" centers / sold separately

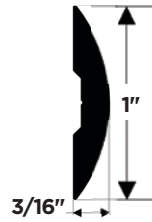

A50-0199

Part Number	Color	Length	Screw*
A50-0199TAL12D	Polished Clear	12'	#6

*Drilled and countersunk on " centers / sold separately



FLEXIBLE VINYL

FLEXIBLE VINYL - ACCEPTS FLEXIBLE INSERT

V11-0809

Insert: V12-0810

Part Number	Color	Length	Screw*
V11-0809BKA50-1	Black	50'	#8

*Drilled and countersunk on 6" centers / sold separately

AVAILABLE AS A RUB RAIL KIT (pg. 61)

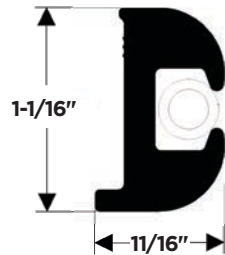

V11-0899

Insert: V12-0005

Part Number	Color	Length	Screw*
V11-0899BKA100	Black	100'	#10

*Drilled and countersunk on 6" centers / sold separately

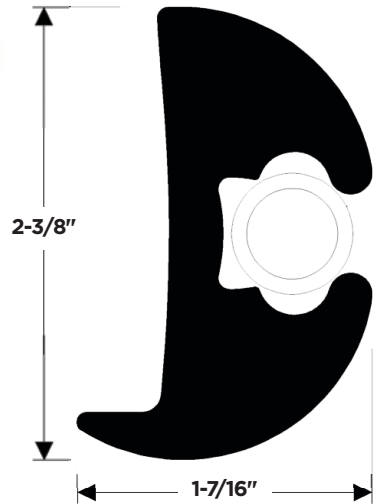

V11-2423

Insert: V12-0003

Part Number	Color	Length	Screw*
V11-2423BKA50-1	Black	50'	#10
V11-2423BKA70-1	Black	70'	#10
V11-2423BKA100-1	Black	100'	#10

*Drilled and countersunk on 6" centers / sold separately

AVAILABLE AS A RUB RAIL KIT (pg. 61)

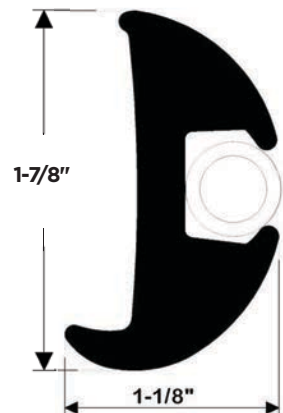

FLEXIBLE VINYL ACCEPTS FLEXIBLE INSERT

V11-3161

Insert: V22-3162

Part Number	Color	Length	Screw*
V11-3161BKA50-1	Black	50'	None

#10 screw intended for insert / drilled countersunk on 6" centers / sold separately

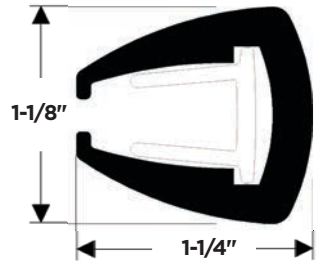

V11-3426

Insert: V12-0005

Part Number	Color	Length	Screw*
V11-3426BKA50-1	Black	50'	#8
V11-3426BKA70-1	Black	70'	#8

*Drilled and countersunk on 6" centers / sold separately

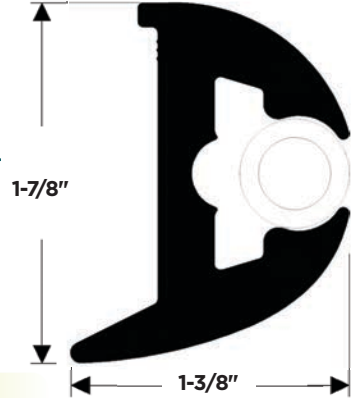

AVAILABLE AS A RUB RAIL KIT (pg. 61)

V11-3447

Insert: V12-0003

Part Number	Color	Length	Screw*
V11-3447BKA50-1	Black	50'	#8
V11-3447BKA70	Black	70'	#8

*Drilled and countersunk on 6" centers / sold separately

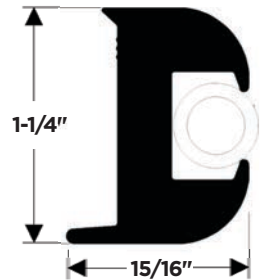

AVAILABLE AS A RUB RAIL KIT (pg. 62)

V11-4014

Insert: V12-0003

Hull Stiffener: A40-0812 (recommended)

Part Number	Color	Length
V11-4014BKA70	Black	70'

#10 screw intended for use with hull stiffener (recommended with this Rub Rail / drilled countersunk on 6" centers / sold separately

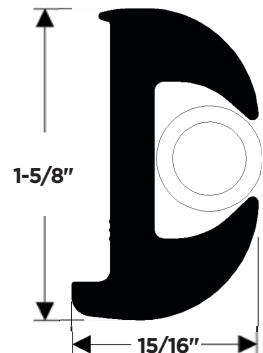

FLEXIBLE VINYL ACCEPTS STAINLESS STEEL INSERT

V11-9669

Insert: S11-4690

Part Number	Color	Length	Screw*
V11-9669WHA100	Arctic White	100'	#8

#8 screw intended for insert / drilled countersunk on " centers / sold separately

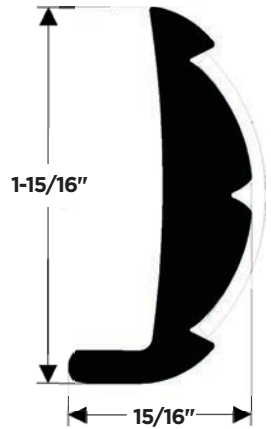

V11-9752

Insert: S11-4650

Part Number	Color	Length	Screw*
V11-9752BKA50	Black	50'	N/A*

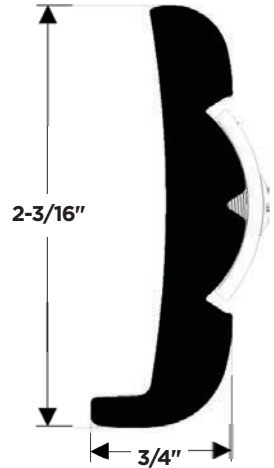

V11-9798

Insert: S11-4511

Part Number	Color	Length	Screw*
V11-9798WHA60D	Arctic White	60'	#8
V11-9798BKA61D	Black	61'	#8
V11-9798BKA50	Black	50'	#8
V11-9798BKA52067D	Black	52'	#8
V11-9798BKA55	Black	55'	#8
V11-9798BKA5605D	Black	56'	#8
V11-9798GVI61D	Gray	61'	#8
V11-9798WHA50D	Arctic White	50'	#8
V11-9798WHA61D	Arctic White	61'	#8
V11-9798WHC48D	Frosty White	48'	#8

*Drilled and countersunk on 6" centers / sold separately

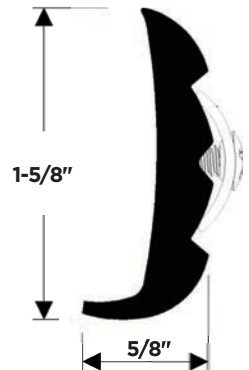

*Does not come pre-drilled. Screws are up to customer discretion.

FLEXIBLE VINYL DOCK BUMPER

V11-0961

Part Number	Color	Length	Screw*
V11-0961WHA6	Arctic White	6'	N/A*

*Drilled and countersunk on 2" centers / sold separately

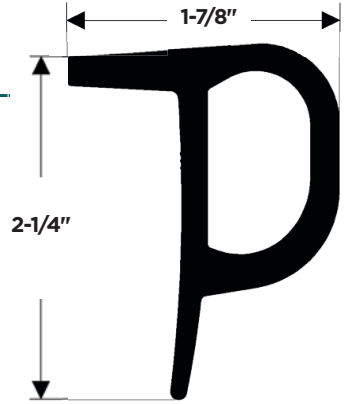

V11-0948

Part Number	Color	Length	Screw*
V11-0948WHA6	Arctic White	6'	N/A*
V11-0948WHA20	Arctic White	20'	N/A*

*Drilled and countersunk on 6" centers / sold separately

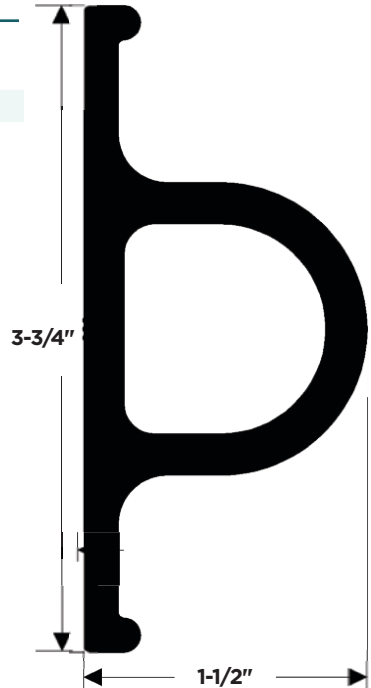

*Does not come pre-drilled. Screws are up to customer discretion.

OVERLAY / INSERT

STAINLESS STEEL

S11-450S*

Stainless Steel Type-304 Overlay

Part Number	Color	Length	Screw*
S11-450SP12	Polished	12'	#6

*Drilled and countersunk on 6" centers / sold separately

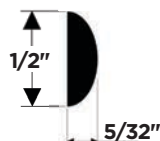

S11-451S*

Stainless Steel Type-316 Overlay

Part Number	Color	Length	Screw*
S11-451SP12B	Polished	12'	#10

*Drilled and countersunk on 6" centers / sold separately

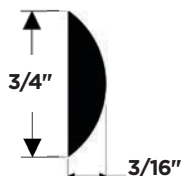

S11-465*

Stainless Steel Type-316 Overlay

Part Number	Color	Length	Screw*
S11-465SP20B	Polished	20'	#12

*Drilled and countersunk on 6" centers / sold separately

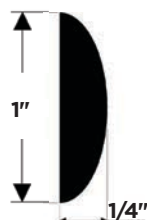

* Can also be used as an insert with certain Rub Rail profiles or used on its own as chafe or bumper protection.



Ideal Chafe Protection

TACO Marine's hollow back and solid back stainless-steel overlays and inserts have other applications. They can be used as **chafe protection** for your boat with or without use of any extruded rub rail. They can also be a nice addition to any current flat face rub rail to provide a clean and updated look to your boat.

OVERLAY/INSERT STAINLESS STEEL

S11-467S

Stainless Steel Type-316 Overlay

Part Number	Color	Length	Screw*
S11-467SP20B	Polished	20'	#12

*Drilled and countersunk on 6" centers / sold separately

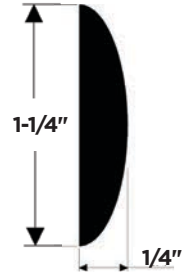

S11-469S

Stainless Steel Type-316 Overlay

Part Number	Color	Length	Screw*
S11-469SP20B	Polished	20'	#12

*Drilled and countersunk on 6" centers / sold separately

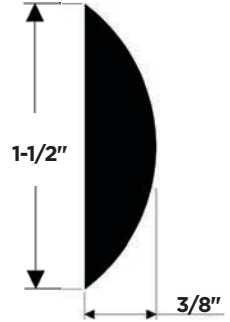

S11-4500

Stainless Steel Type-316 Overlay

Part Number	Color	Length	Screw*
S11-4500P12	Polished	12'	#6

*Drilled and countersunk on 6" centers / sold separately

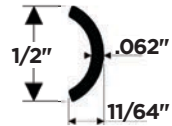

S11-4511

Stainless Steel Type-316 Overlay

Part Number	Color	Length	Screw*
S11-4511P12	Polished	12'	#8
S11-4511P16	Polished	16'	#8
S11-4511P16B	Polished	16'	#8
S11-4511P20	Polished	20'	#8

*Drilled and countersunk on 6" centers / sold separately

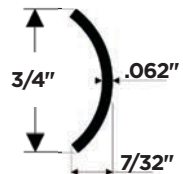

S11-4650

Stainless Steel Type-304

Part Number	Color	Length	Screw*
S11-4650P12	Polished	12'	#10

*Drilled and countersunk on 6" centers / sold separately

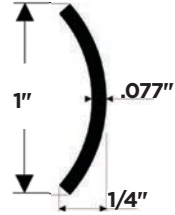

S11-4670

Stainless Steel Type-304

Part Number	Color	Length	Screw*
S11-4670P12	Polished	12'	#10

*Drilled and countersunk on 6" centers / sold separately

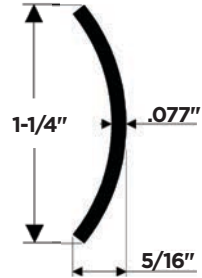

S11-4690

Stainless Steel Type-304

Fits Rub Rail: V11-9669

Part Number	Color	Length	Screw*
S11-4690P12	Polished	12'	#10
S11-4690P12B	Polished	12'	#10

*Drilled and countersunk on 6" centers / sold separately

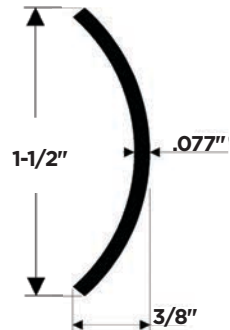

OVERLAY/INSERT FLEXIBLE VINYL

V12-0003

Flexible Vinyl

Fits Rub Rail: V11-2423, V11-3447, V11-4014

Part Number	Color	Length
V12-0003BKA50-1	Black	50'
V12-0003BKA70-1	Black	70'
V12-0003WHA50-1	Arctic White	50'
V12-0003WHA70-1	Arctic White	70'

*Drilled and countersunk on 6" centers / sold separately

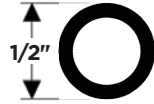

V12-0005

Flexible Vinyl

Fits Rub Rail: V11-0899, V11-3426

Part Number	Color	Length
V12-0005BKA50-1	Black	50'
V12-0005BKA70-1	Black	70'

*Drilled and countersunk on 6" centers / sold separately

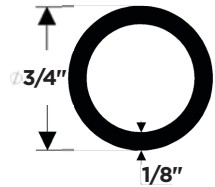

V12-0303

Fits Rub Rail:

A12-0303, A12-0305, V21-9517, V21-9602, V21-9501

Part Number	Color	Length
V12-0303BKA50-1	Black	50'
V12-0303BKA70-1	Black	70'
V12-0303WHA50-1	Arctic White	50'
V12-0303WHA70-1	Arctic White	70'
V12-0303WHC50-1	Frosty White	50'
V12-0303WHC70-1	Frosty White	70'

*Drilled and countersunk on 6" centers / sold separately

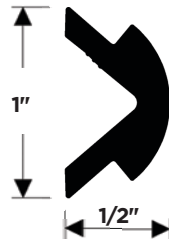

V12-0317

Fits Rub Rail: A11-0317

Part Number	Color	Length
V12-0317BKA50-1	Black	50'
V12-0317WHA50-1	Arctic White	50'

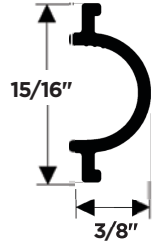

V12-0338

Fits Rub Rail: A11-0638

Part Number	Color	Length
V12-0338BKA50-1	Black	50'
V12-0338BKA70-1	Black	70'

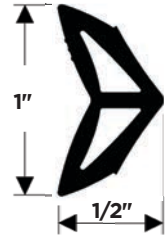

V12-0342

Fits Rub Rail: A11-0342

Part Number	Color	Length
V12-0342BKA50-1	Black	50'

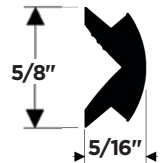

OVERLAY/INSERT FLEXIBLE VINYL

V12-0810

Fits Rub Rail: V11-0809

Part Number	Color	Length
V12-0810BKA50-1	Black	50'
V12-0810WHA50	Arctic White	50'

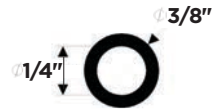

V12-4144

Fits Rub Rail: V21-9678

Part Number	Color	Length
V11-4144BKA50-1	Black	50'
V11-4144BKA70-1	Black	70'

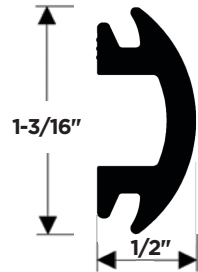

V12-4155

Fits Rub Rail: A11-0347

Part Number	Color	Length
V11-4155BKA50-1	Black	50'

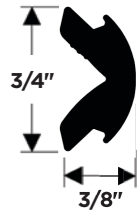

V12-9787

Fits Rub Rail: A11-0347

Part Number	Color	Length
V12-9787BKA250	Black	250'

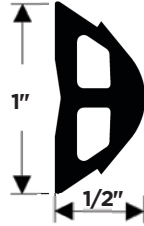

V22-3162

Fits Rub Rail: V11-3161
Sandwich Style Rigid Vinyl

Part Number	Color	Length
V12-3162BKA12	Black	12'

*Drilled and countersunk on 6" centers / sold separately

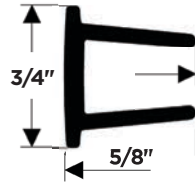

OVERLAY/INSERT FLEX CHROME

V12-0307

Fits Rub Rail:
V21-9501, V21-9517, V11- 9960, V21-9990

Part Number	Color	Length
V12-0307CP200	Chrome	200'
V12-0307BP60	Black Pearl	60'
V12-0307BP80	Black Pearl	80'
V12-0307CP60	Chrome	60'
V12-0307CP80	Chrome	80'

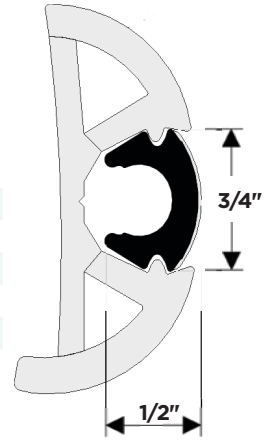

V12-1069

Fits Rub Rail: V21-9662

Part Number	Color	Length
V12-1069CP165	Chrome	165'

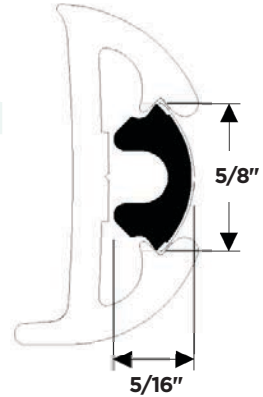

V12-9809

Fits Rub Rail: V21-9811

Part Number	Color	Length
V12-9809CP70	Chrome	70'
V12-9809CP120	Chrome	210'

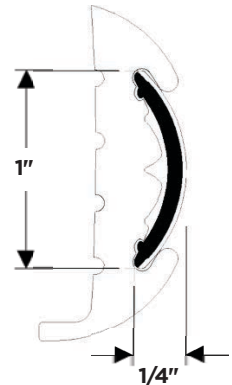

OVERLAY/INSERT FLEX CHROME

V12-9873

Fits Rub Rail: V21-9678

Part Number	Color	Length
V12-9873CP50	Chrome	50'

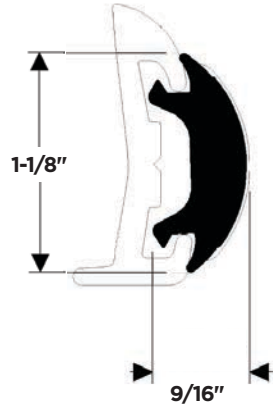

V12-9980

Fits Rub Rail: V11-9970

Part Number	Color	Length
V12-9980CP100-1	Chrome	100'

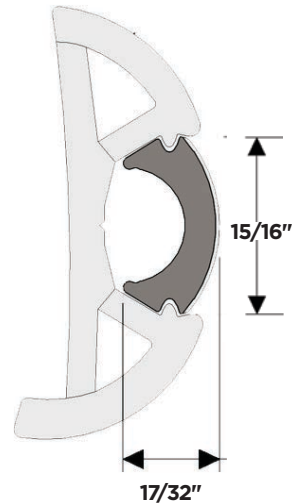

ACCESSORIES

Stiffener

Aluminum Flat Bar Stiffener

Part Number	Color	Length	Screw*
A40-0812AEY10D2	Mill	10'	#10

Use with flexible rub rail behind insert for smooth installation

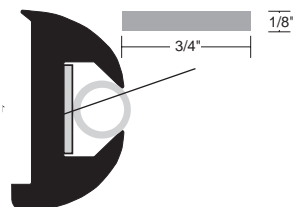

Recommended for V11-4014 Rub Rail (pg. 46) to avoid waves forming on rub rail due to the tightening of the screws.

Rub Strakes

Stainless Steel Type-304L

Part Number	Length	Width	Screw
S11-1700P8	8"	3/4"	#8
S11-1700P12	12"	3/4"	#8
S11-1700P18	18"	3/4"	#8
S11-1700P24	24"	3/4"	#8
S11-1800P12	12"	1"	#10
S11-1800P18	18"	1"	#10
S11-1800P24	24"	1"	#10



Rub Ends

Stainless Steel Type-304L

Part Number	Length	Width	Screw
S11-2000P12	12"	3/4"	#8
S11-2001P12	12"	1"	#10



Ideal chafe protection (pg. 49)

End Caps

Stainless Steel & Nylon

Part Number	Color/Finish	Width	Screw
F16-0039	Stainless Steel	1-5/8"	#8
F16-0091	Stainless Steel	2-19/64"	#8
F16-0272	Stainless Steel	2-1/2"	#8
F16-0274	Stainless Steel	2-27/31"	#8
F16-0276	Stainless Steel	2-3/4"	#8
F90-0001BKN	Black Nylon	2"	#8
F90-0002BKN	Black Nylon	1-9/16"	#8
F90-0750BN	Black Nylon	1"	#4
F90-1870BKA	Black Nylon	1-3/8"	#8



F16-0039



F16-0091



F16-0272



F16-0274



F16-0276



F90-0001



F90-1870



F90-0002



F90-0750

Dive Doors

Stainless Steel

Part Number	Color/Finish	Width	Screw
F16-0273	Stainless Steel	2-1/4"	#8
F16-0275	Stainless Steel	1-27/32"	#8
F16-0277	Stainless Steel	2-3/4"	#8



F16-0273



F16-0275



F16-0277

LED Navigation Lights

Part Number	Amps Draw	Width	Screw
F38-6800D	0.6 @ 12V	5/16"	#8
F38-6800D-2	0.6 @ 12V	5/16"	#8

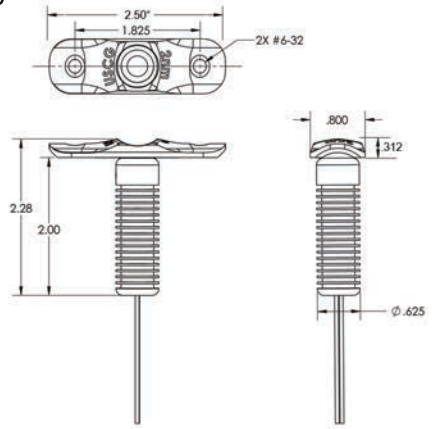

Part Number	Amps Draw	Width	Screw
F38-6810B	0.6 @ 12V	13/16"	#8

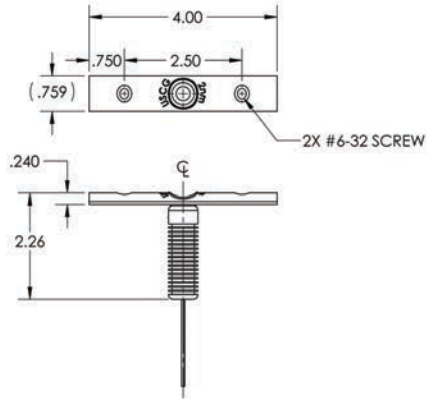
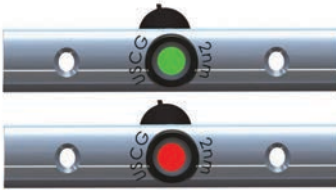

Part Number	Amps Draw	Width	Screw
F38-6602-1	0.6 @ 12V	1-3/4"	#8
F38-6602-1	0.6 @ 12V	1-3/4"	#8

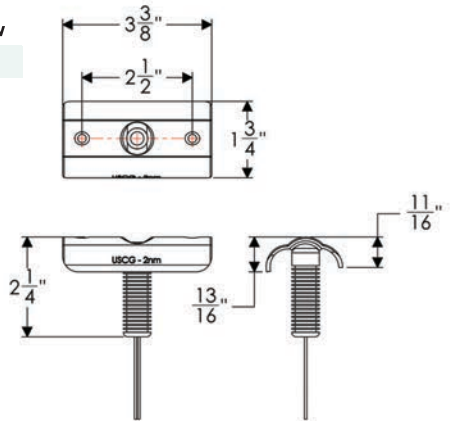
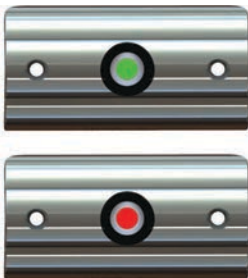

RUB RAIL KITS

FLEXIBLE & SEMI-RIGID RUB RAIL

EASY TO INSTALL AND AVAILABLE IN MOST STORES

Kit Includes

- VINYL RUB RAIL
- INSERT (IF NEEDED)
- END CAPS
- STAINLESS STEEL SCREWS



V11-0809

Material: Flexible Vinyl
Insert: V12-0810

Part Number	Color	Length
V11-0809BBK50-2	Black/Black	50'
V11-0809BBK70-2	Black/Black	70'
V11-0809BWK50-2	Black/Arctic White	50'

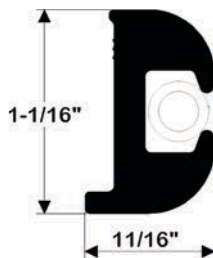

V11-2423

Material: Flexible Vinyl
Insert: V12-0003

Part Number	Color	Length
V11-2423BBK50-2	Black/Black	50'
V11-2423BBK70-2	Black/Black	70'

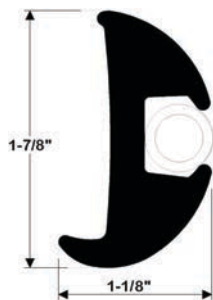

V11-3426

Material: Flexible Vinyl
Insert: V12-0005

Part Number	Color	Length
V11-3426BBK50-2	Black/Black	50'
V11-3426BBK70-2	Black/Black	70'

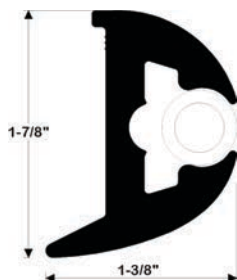

*Not to scale. For accurate scaling see page 45 & 46.

RUB RAIL KITS

V11-3447

Material: Flexible Vinyl
Insert: V12-0003

Part Number	Color	Length
V11-3447BBK50-2	Black/Black	50'
V11-3447BBK70-2	Black/Black	70'
V11-3447BWK50-2	Black/Arctic White	50'
V11-3447WWK50-2	Arctic White/Arctic White	50'

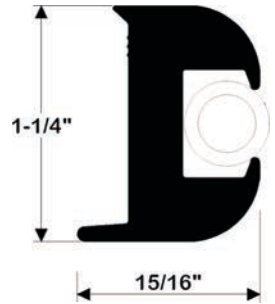

V11-4135

Material: Semi-Rigid Vinyl
No Insert

Part Number	Color	Length
V11-4135BKA30-3	Black	30'

SOLD ONLY AS A RUB RAIL KIT

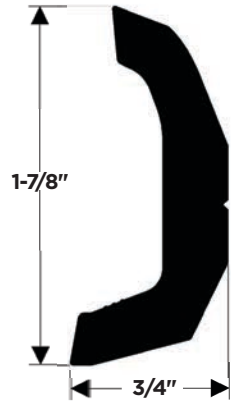

V11-9795

Material: Semi-Rigid Vinyl
Insert: V12-4144

Part Number	Color	Length
V11-9795BKA50D-2	Black/Black	50'

SOLD ONLY AS A RUB RAIL KIT

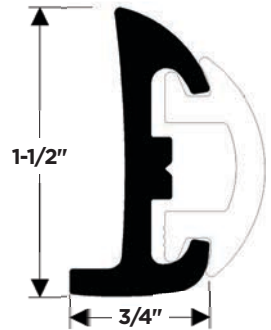

V11-9811*

Material: Semi-Rigid Vinyl
Insert: V12-9809 Flex Chrome

Part Number	Color	Length
V11-9811WCM70-2	Frosty White / Chrome	70'

*Not to scale. For accurate scaling see page 33

SOLD ONLY AS A RUB RAIL KIT



SUPRO-FLEX

SuproFlex Rub Rail Kits are available in a variety of sizes and colors, and pairs with TACO's patented Flex Chrome Insert.

V11-9960

Insert: V12-0307 Flex Chrome

Part Number	Color	Length
V11-9960BBK60-2	Black / Flex Chrome	60'
V11-9960WCM60-2	Frosty White / Flex Chrome	60'

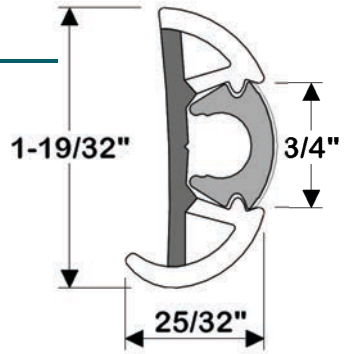

V11-9990

Insert: V12-0307CP Flex Chrome

Part Number	Color	Length
V11-9990BBK60-2	Black / Flex Chrome	60'
V11-9990BBK80-2	Black / Flex Chrome	80'
V11-9990GRD80-2	Gray / Flex Chrome	80'
V11-9990WCM60-2	Frosty White / Flex Chrome	60'
V11-9990WCM80-2	Frosty White / Flex Chrome	80'

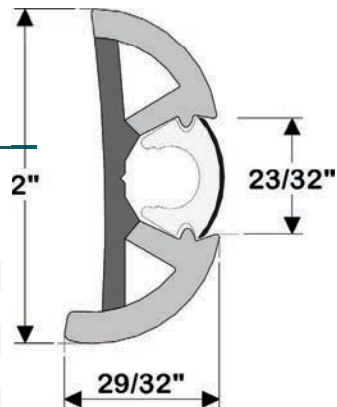

*Not to scale. For accurate scaling see page 26 and 27.

FOR INSTALLATION INSTRUCTIONS & VIDEOS, VISIT TACOMARINE.COM

At TACO, we have comprehensive instructions and how-to videos on our website and on our popular YouTube channel [youtube.com/tacomarine](https://www.youtube.com/tacomarine). Additionally, we offer technical support for any of your Rub Rail installation questions. Simply visit [tacomarine.com/technical-support](https://www.tacomarine.com/technical-support) to get started.

   @tacomarine

 @taco_marine

#TrollTheEdge

TACO[®]
MARINE

Explore our complete line of
Rub Rail products today.

[TACOMARINE.COM](https://www.tacomarine.com)

   @tacomarine  @taco_marine [#TACORUBRAIL](https://www.tacomarine.com)

V20 2021

Dealer: