

ADA-F1

www.seaviewglobal.com

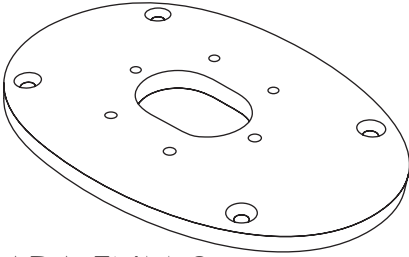

ADA-FNM-2

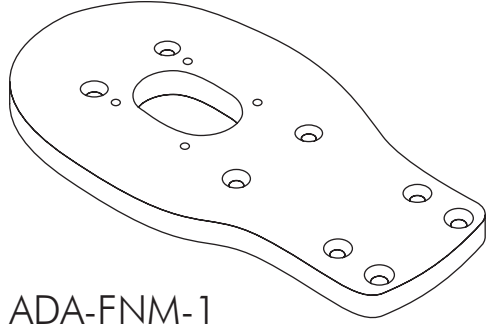

ADA-FNM-1

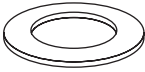

x6

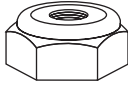

x4

5/16" - 18

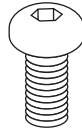

x6

M6 x 16mm

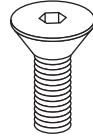

x8

5/16" - 1 1/4"

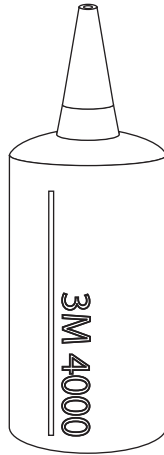

3/16" = 4.763mm

1

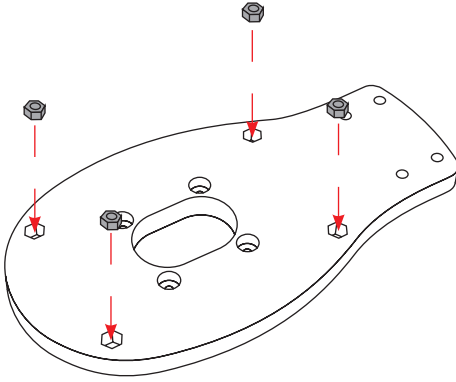

2

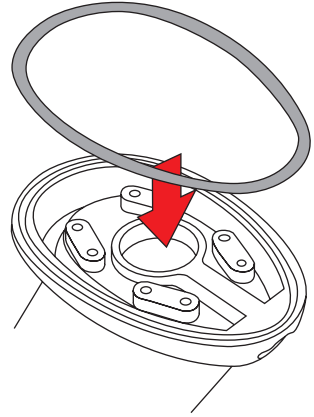

3

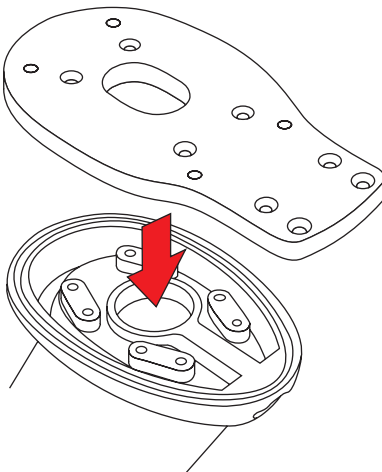

4

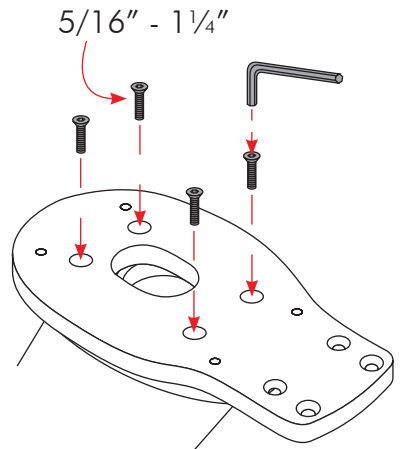

5

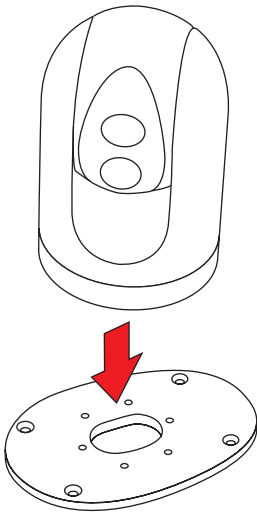

6

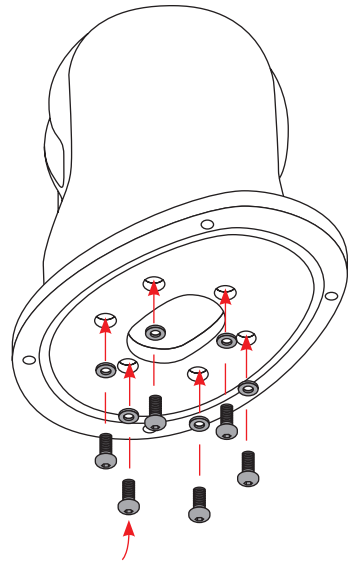

M6 x 16mm

7

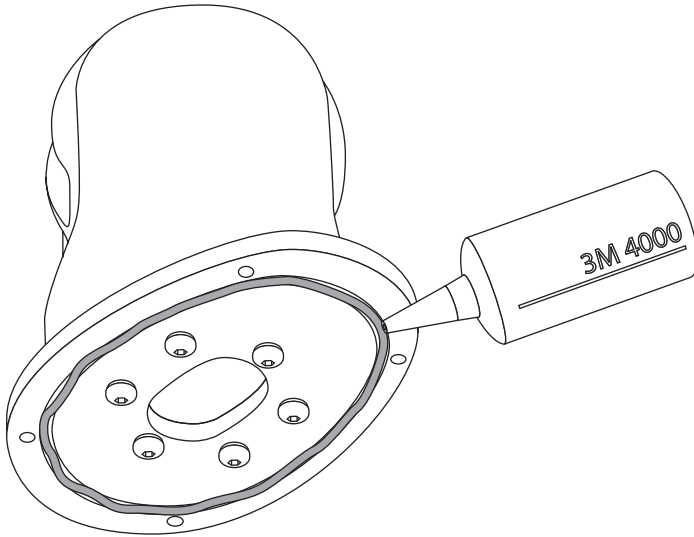

8

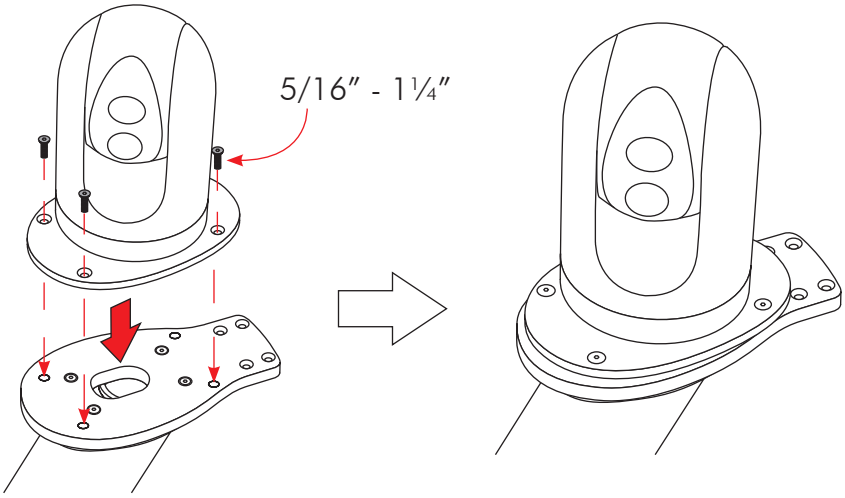

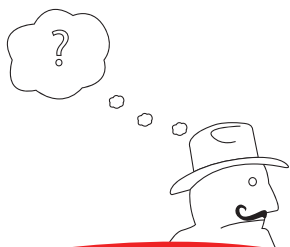

North American Office

12532 Beverly Park Road,
Lynnwood, WA 98087
Tel: 800-523-7558
Fax: 425-355-3661
www.seaviewglobal.com

European Office

Tel: +33 4 94 53 27 70
Fax: +33 4 94 53 26 62
ZI Du Capitou, 85 Rue Louis Lepine,
Frejus 83600 - France
www.seaviewprogress.com